

Karl Buschmann
Maschinenbau GmbH

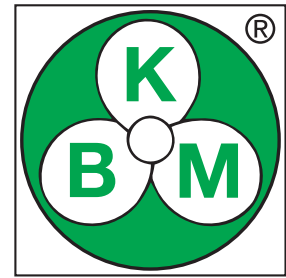

Slurry Agitators and Systems

www.guelleruehrwerke.de

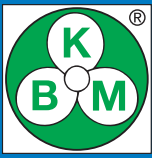

Contents

Slurry and substrate are not standardised substances. This is why we can only offer estimates and recommendations for agitator technology.

Due to the many different types of pits and systems, no general advice can be given on how to operate best.

Technical and visual product specifications are subject to change (product improvements).

Errors and omissions excepted

We can supply accessories and spare parts for all slurry mixers/agitators currently on the market.

Orders are subject to our General Purchasing and Sales Terms & Conditions as amended from time to time. They can be found on our website. A copy of the Terms & Conditions is available on request.

Type "B" bearing technology	3	Slurry mixer frame extension	
Type "C" bearing technology	3	Longhorn type	31
Type "C/E" bearing technology	4	Type 2 PTO mixers	32
Type "E" bearing technology	4	Propeller skid, standard version	33
Type "E/HEM" bearing technology	4	Propeller skid, reinforced version	33
		Propeller skid with tyre bracket	33
Circulation mixing in a type "1" forced circulation system	5	Diggermix Front loader bracket	34
Slurry slalom system L-E1 range	6	Hydraulic drives	35
Electric slurry mixer type L-E1-102	7	Elevated slurry tank mixer mounting	35
Electric slurry mixer type Speed	8	Type S-E2 electric mixer	36
		Cart for type S-E2 electric mixer	36
Installation box with guide rail	9/10	Protective ring S-E2	37
Installation box – two-part	10	Propeller skid S-E2	37
Installation box – for doweling	11	S-E2 bracket, fixed	37
Guide rails – custom designs	11	Type S-E2 bracket	37
Accessories overview	12	Mobile Slatted-floor agitators with quick change device	38/39
Installation dimensions for round propeller cage Ø 720 mm	13	Slatted-floor slurry agitators SP 1-3/80	40
Installation dimensions for propeller cage 625 x 625 mm	14	Slatted-floor slurry agitators SP 3-3/80	40
Installation dimensions – universal drawing	15	Type K Slatted-floor agitators for cow slurry	41
Installation instructions for forced circulation systems	16	Type S Slatted-floor agitators for pig slurry	41
Constant velocity drive shaft	17	F1-168 and F2-168 slurry mixers	42
Propeller cages	18	Mixers for elevated containers	
Hanging clamp	18	Type HEM 1	43
Clamp range	18	Type HEM 2	43
		Type HEM 3	43
Standard mixing propeller	19	Accessories	43
Turbo mixing propeller	19	Type HEM 6 installed mixer	44
Folding mixing propeller	19	angle bracket	44
		assembly jig	44
Support bracket	20	compensator	44
Universal mixer installation bracket	20	mixer nozzle	45
Lower linkage mounting	20	External drive unit	45
Fixed installation bracket	20	Type HEM 7	46
Cage bracket	20	Type HEM 8	46
		Press-seal plates	46
Reversing gearbox	21	Super HEM 6	47
Angled drive	21	Comparison of HEM 6/Super HEM 6	48
Universal mount for speed agitators	21	Type Biogas 1031 electric installed mixer	49
Pipe reinforcement	22	Mixer system for biogas digesters	50
Sacrificial anode	22	Paddel-Profi, the whispering giant	51
Oil expansion tank	22	Installed mixer Fermix type	52
		Installed mixer Fermix-Flex type	53
Pivoting three point attachment	23	Installed mixer Super Fermix type	54
Wheeled chassis for slurry mixers	23	Centro Mix Centro Mix type	55
Pivoting three point attachment, pivoting 2Hy	24	BoBuMix-168 large propeller mixer	56/57
Pivoting three point attachment, kinked	24	Type L-E2 electric mixer	58
		Hydraulic front loader agitator	59
Fixed three point attachment, to 6200 mm	25	Mixer tower - fixed	60
Fixed three point attachment, to 10000 mm	25	Mixer tower - pivoting series I	61
Type "E" lagoon mixer	26	Mixer tower - pivoting series II	62/63
Type "E" lagoon mixer – lattice construction	27	Circum Maxx	64/65
Lagoon booster	28/29	Plurry Maxx	66/67
Lagoon mixers for fixed installation	30		

Our perfection – Your success

Our powerful slurry equipment fulfils all possible operational requirements. Its robust design ensures maximum performance, long life and low maintenance. Thanks to the wide range of types available, proper agitation and mixing of different types of liquid manure is always achieved irrespective of the slurry storage or tank used.

The robust bearings and seals are designed for continuous operation:

- Maximum performance through dynamically shaped propeller blades
- Robust welded structure of the overall design
- All parts are galvanised as far as possible
- Smooth running due to balanced mixing propeller

Two different bearing systems are used:

- Roller bearings, maintenance free, max. speed 1000 rpm
- Roller and slide bearings, max. speed 540 rpm

Type "B" bearing technology

The type B-60 slurry mixer is recommended for use in 3 x 8m pits.

It is equipped with combined roller-slide bearings and designed for opera-

tion in 455 x 455 mm or round Ø 450 mm access holes.

Standard equipment type "B"

Outside tube:	Ø 60 mm
Bearing:	Roller bearing and slide bearing
Bearing spacing:	2100 mm, may be less depending upon length
Standard lengths:	3700, 4200, 4600, 5200 mm
PTO connection:	1 3/8" Z6 DIN 9611
Power consumption:	20-30 hp (15-22 kW) at 540 rpm
Mixing propeller:	Suction propeller Ø 380 mm
Direction of rotation:	Only approved as suction mixer, single direction of rotation
Capacity:	At 540 rpm = 1212 m ³
Propeller cage:	450 x 450 mm, all edges raised, with Ø 415 mm blade passage hole
Weight:	45 kg at a mixer length of 4200 mm

Type "C" bearing technology Roller and slide bearings

The type "C" range of mixers is considerably less expensive than the "E" type machines, their speed however is limited

to 540 rpm max. This is a mandatory requirement due to the use of a slide bearing. The design of the "C" range machines

allows for operation in suction mode only.

Other than the speed limit, performance of the machines is identical.

Serienausstattung Typ "C-76" and "C-102"

Outside tube:	Ø 76 mm or Ø 102 mm, depending upon the type (C-76 or C-102)
Bearing:	Roller bearing and slide bearing
Bearing spacing:	2100 mm, may be less depending upon length
Standard lengths:	3700, 4200, 4600, 5200, 6000 mm
PTO connection:	1 3/8" Z6 DIN 9611
Power consumption:	60-80 hp (44-49 kW) at 540 rpm
Mixing propeller:	Suction propeller Ø 560 mm, other diameters available
Direction of rotation:	Only approved as suction mixer, single direction of rotation
Capacity:	3352 m ³ at 540 rpm
Propeller cage:	625 x 625 mm, all edges raised, with Ø 590 mm propeller passage hole, other sizes available
Weight:	Mixer type C1-102, 4200 mm = 122 kg

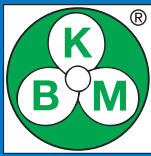

Our perfection – Your success

Type "C/E" bearing technology **Roller and slide bearings**

The "C/E-102" slurry mixer uses roller bearing and slide bearing technology. The type C/E-102 mixer is designed for alternating axial loads which makes it suitable for 2 way rotation ope-

ration. During inverted operation the drive shaft is however submitted to very high axial loads and we therefore recommend the use of the inverter box only with the "E" series mixers where the

radial force is absorbed through the propeller area. Technical specifications are identical to those of the C-102 mixer. The maximum speed of the C/E-102 mixers is 540 rpm. As a low-cost alternative

with a reduced selection of accessories, the "C/E" series is also available with an outer tube Ø 76 mm.

Standard equipment type "C/E-76" and "C/E-102"

Outside tube:	the "C/E" series is also available with an outer tube Ø 76 mm
Bearing:	Roller bearing and slide bearing
Bearing spacing:	2100 mm, may be less depending upon length
Standard lengths:	3700, 4200, 4600, 5200, 6000 mm, custom lengths up to 6000 mm available
PTO connection:	1 3/8" Z6 DIN 9611
Power consumption:	60-80 hp (44-49 kW) at 540 rpm
Mixing propeller:	Suction propeller Ø 560 mm, other diameters available
Direction of rotation:	Alternating as required, sucking or pushing (drawing and damming)
Capacity:	3352 m³ at 540 rpm
Propeller cage:	625 x 625 mm, all edges raised, with propeller passage hole Ø 590 mm, other sizes available
Weight:	type C/E1-102, 4200 mm = 122 kg

Type "E" bearing technology **Roller bearings**

The "E" mixer range comes equipped with roller bearings.

Maintenance-free main bearings (2 RS closed deep groove ball bearings) and a specialised sealing system allow the mixer to be operated without an oil filling.

Two rotary shaft lips type seals together with grease chambers ensure the required sealing. The rotary shaft lips type seals are mechanically protected against foreign objects. The liner of the rotary shaft lips type seals consists of high grade polished stainless steel which prevents oxidati-

on. The maximum bearing spacing of the main bearings is 1500 mm. This type of bearing layout allows for mixer speeds of 1000 rpm. For small pit openings, it is often advantageous to work with a small mixing propeller and 1000 rpm.

Mixers of types E1-102, E2-102, L-E1, L-E2 are equipped with this bearing system and approved for 1000 rpm.

Standard equipment type "E-102" (does not apply to series L-E1/L-E2)

Outside tube:	Ø 102 mm
Bearing:	Maintenance-free roller bearing
Bearing spacing:	1500 mm, may be less depending upon length
Standard lengths:	3700, 4200, 4600, 5200, 6000, 7000, 8000, 9000, 10000, 11000, 12000 mm Custom lengths 400 to 12000 mm available, others upon request
PTO connection:	1 3/8" Z6 DIN 9611
Power consumption:	60-80 hp (44-59 kW) at 540 rpm, 130-160 hp (95-117 kW) at 1000 rpm
Mixing propeller:	Suction propeller Ø 560 mm; other diameters available Pusher propeller Ø 560 mm; other diameters available
Direction of rotation:	Alternating as required, sucking or pushing (drawing or damming)
Capacity:	3352 m³ at 540 rpm
Propeller cage:	625 x 625 mm, all edges raised, with propeller passage hole Ø 590 mm, other sizes available
Weight:	for mixer length of 4200 mm = 125 kg

Type "E/HEM" bearing technology **Oil filled**

For a supplementary price on the types E and L-E, an oil filling is available together with a different type of bearing. The E/HEM bearing technology is a combination of the tried and tested HEM bearing used in the stationary and type E mixers.

The lower bearing system comprises two taper roller bearings, as do the central and top bearings. The maximum spacing of the central bearing is 1500 mm. The E/HEM bearing system is designed for continuous operation

at a maximum speed of 1000 rpm and two-way alternating rotational direction. E/HEM bearing systems are particularly well suited to permanently installed mixers. For optimum lubrication of the upper seal we recommend the fitting

of an oil expansion tank. When only used occasionally, the standard model with rotary shaft lips type seals will be adequate. For prolonged periods of operation we recommend using a mechanical seal.

Slurry mixers and accessories

Circulation mixing in a type "1" forced circulation system

In a forced circulation system, the slurry mixer is stationary in a separate location between the suction and discharge sides. This system has been tried and tested for years and is the only means of ensuring proper agitation, preventing the mixed slurry from being drawn

back to the suction zone of the propeller. Where not expressly specified at the time of ordering, all range "1" mixers are supplied with a suction propeller. This is a requirement under the Dutch circulation mixing method. Our circulation mixing systems have the common denominator "1", as in types B1-60, C1-76, C1-102, C/E1-76, C/E1-102

or E1-102, the denomination "1" referring to one propeller cage. The standard dimension of our propeller cages is 625 x 625 with a propeller passage diameter of 590 mm. All edges of the 6mm mounting plate of the cage are raised so that the largest possible mixing propeller can be used despite the small external dimensions. The smaller the propeller

the sooner the mixing process in the circulation system can start. The use of type "1" mixers requires either a bracket for the angle mounting or three point attachment.

Type "1" agitators may also be used in open mixing systems.

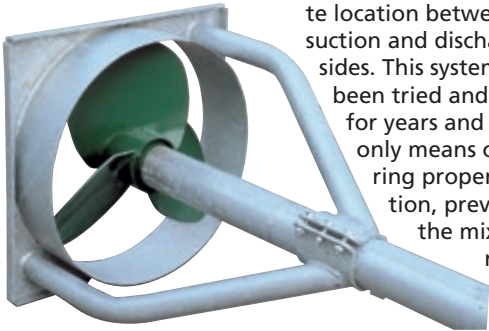

Complete slurry mixers , inclusive of 1 propeller cage, excluding 3 point linkage

Slurry-agitators Typ	Ex-ternal tube Ø mm	Standard mixer shaft lengths								
		3.700 mm Order no.	4.200 mm Order no.	4.600 mm Order no.	5.200 mm Order no.	6.000 mm Order no.	7.000 mm Order no.	8.000 mm Order no.	9.000 mm Order no.	
B1-60	60	B1- 60-3700	B1- 60-4200	B1- 60-4600	B1- 60-5200					
C1-76	76	C1- 76-3700	C1- 76-4200	C1- 76-4600	C1- 76-5200	C1- 76-6000				
C1-102	102	C1- 102-3700	C1- 102-4200	C1- 102-4600	C1- 102-5200	C1- 102-6000				
C/E1-76	76	C/E1- 76-3700	C/E1- 76-4200	C/E1- 76-4600	C/E1- 76-5200	C/E1- 76-6000				
C/E1-102	102	C/E1- 102-3700	C/E1- 102-4200	C/E1- 102-4600	C/E1- 102-5200	C/E1- 102-6000				
E1-102	102	E1- 102-3700	E1- 102-4200	E1- 102-4600	E1- 102-5200	E1- 102-6000	E1- 102-7000	E1- 102-8000	E1- 102-9000	
E1-102	102	E1- 102-10000	E1- 102-11000	E1- 102-12000	Further lengths upon request					

Mixer type	Propeller cage	Mixer propeller	Shaft bearing	Speed limit
B1-60	450 x 450 mm	Ø 380-suction	Roller bearing + slide bearing	540 1/min
C1-76	625 x 625 mm	Ø 560-suction	Roller bearing + slide bearing	540 1/min
C1-102	625 x 625 mm	Ø 560-suction	Roller bearing + slide bearing	540 1/min
C/E1-76	625 x 625 mm	Ø 560-suction	Roller bearing + slide bearing	540 1/min
C/E1-102	625 x 625 mm	Ø 560-suction	Roller bearing + slide bearing	540 1/min
E1-102	625 x 625 mm	Ø 560-suction	Maintenance free roller bearing	1.000 1/min

Price supplements	Order no.
Increase the standard mixing propeller diameter from Ø 560 mm to Ø 700 mm	A-Preis-001
Propeller cage Ø 720 mm instead of 625 x 625 mm (use in concrete cone)	A-Preis-002
Mechanical seal SiC/SiC with oil fillig supplement on mixer type E-102	A-Preis-015
Oil filling, supplement on mixer type E-102	A-Preis-016
Turbo propeller Ø 560 mm instead of standard propeller Ø 560 mm. Available with stirrer Ø 102	A-Preis-019
Turbo propeller Ø 600 mm instead of standard propeller Ø 560 mm. Available with stirrer Ø 102	A-Preis-020
Gearbox flange (only Typ C/E1-102 or E1-102)	Z-Flansch-001
Accessories	Order no.
Support bracket	Z-Halterung-001
Universal mixer installation box	Z-Halterung-002
Lower linkage mounting	Z-Halterung-003
Installation box, stationary	Z-Halterung-007
Hanging clamp	Z-Schelle-001
Reversing gearbox	Z-Getriebe-001
Angled drive, fitted	Z-Getriebe-002
T gearbox, fitted	Z-Getriebe-003
Three point attachment, swivelling	With adjustment spindle, for mixer length up to 4.500 mm 5.500 mm 6.200 mm DB-sw-4500-Sp DB-sw-5500-Sp DB-sw-6200-Sp
Three point attachment, swivelling, angled	With lower linkage mounting, for mixer length up to 4.500 mm 5.500 mm 6.200 mm DB-sw-4500-UH DB-sw-5500-UH DB-sw-6200-UH
Three point attachment, rigid	With adjustment spindle, for mixer length up to 4.500 mm 5.500 mm 6.200 mm DB-st-4500-Sp DB-st-5500-Sp DB-st-6200-Sp
Oil expansion tank	Z-Ölbehälter-01
Sacrificial anode	Z-Opferanode-01

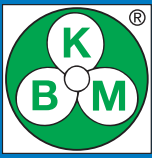

Slalom slurry system



L-E1 range

In a slalom mixing system the channels are laid out such that the slurry circulates in slalom fashion beneath the stables. A central unit is responsible for homogenising and mixing the slurry so it is ready for subsequent pumping.

This system requires an even number of channels plus a return channel to be present. The slurry mixer must achieve sufficient mixing capacity during homogenisation and cause the slurry to circulate at regular intervals. It may be driven by a PTO slurry mixer or an L-E1 or Speed range electric mixer. The electric slurry mixer offers the

advantage of daily mixing using an interval scheduling timer. Thorough daily mixing is required in a slalom system which is easily achieved using the interval scheduling controller.

As an additional item, we recommend the use of a continuous drive shaft with a 1 3/8" PTO spline in accordance with DIN 9611.

Thanks to this through shaft, the mixer may be driven using a tractor rather than an electric motor, achieving a higher mixing capacity. Where the mixer is tractor-driven, a means of mechanically disengaging the

electric motor from the drive shaft must be ensured. This is achieved by releasing the clamping device of the motor and removing the V belt.

If separation is not carried out, the electric motor also rotates during the mixing process and burns out. Only units with a minimum driving power of 15 kW and more are suitable for use in slalom systems. Generally speaking, slalom mixing systems cannot be used. A meeting with trained experts is required prior to the planning stage.



Automatic interval timer control unit (Star-delta circuit)



(Soft start circuit)

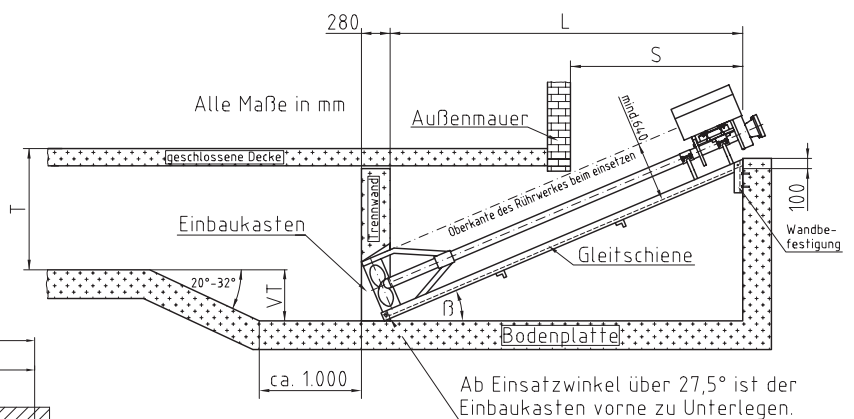
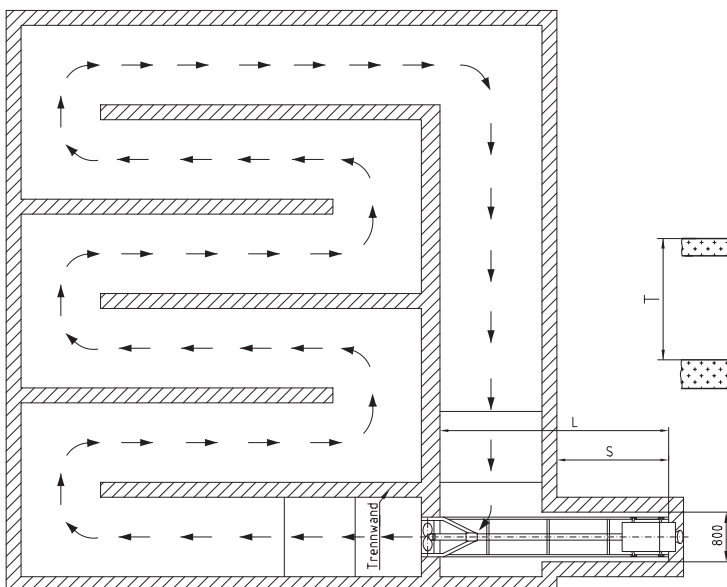

Slalom Slurry system

Electric slurry mixer type L-E1-102 (516 rpm)

The L-E1 range of slurry mixers is fitted with an electric drive and V-belt gear reduction that protects the drive motor and is fitted with a belt tensioning system. It reduces the speed to 516 rpm. This system has already proven highly successful over many years.

The equipment is of a very low maintenance design. The E1-102 bearing system is used which can run continuously at up to 1000 rpm. The mixer is equipped with a large cowling which ensures quick access to the belt drive via a pivot. The air circulation required for motor cooling is adequate.

For optimum lubrication of the upper seal we recommend fitting an oil expansion tank.

Standard equipment:

- Fully operational slurry mixer, excluding switch and interval control.
- 2 support brackets, brackets for angle rail.
- Propeller cage corresponding to guide rail, standard 625 x 625 mm. No surcharge for intermediate or custom sizes.

Electric slurry mixer type L-E1 (516 rpm)

Shaft bearing: Roller bearing, maintenance-free. All mixer types inclusive of 1 propeller cage and 2 support brackets, brackets for angle rail. For combined operation, drive via tractor/PTO, a maximum speed of 1000 rpm for continuous operation is possible

Preferred lengths: 4200, 4600, 5200, 6000 with motor ratings of 15 kW and 18.5 kW

Slurry-agitators	Motor size kW	Standard agitator lengths: Dimensions = agitator shaft length								
		3.700 mm Order no.	4.200 mm Order no.	4.600 mm Order no.	5.200 mm Order no.	6.000 mm Order no.	7.000 mm Order no.	8.000 mm Order no.	9.000 mm Order no.	Mixing propeller
L-E1-055	5,5	L-E1-055-3700	L-E1-055-4200	L-E1-055-4600	L-E1-055-5200	L-E1-055-6000	L-E1-055-7000	L-E1-055-8000	L-E1-055-9000	Ø 360-P
L-E1-075	7,5	L-E1-075-3700	L-E1-075-4200	L-E1-075-4600	L-E1-075-5200	L-E1-075-6000	L-E1-075-7000	L-E1-075-8000	L-E1-075-9000	Ø 380-P
L-E1-110	11,0	L-E1-110-3700	L-E1-110-4200	L-E1-110-4600	L-E1-110-5200	L-E1-110-6000	L-E1-110-7000	L-E1-110-8000	L-E1-110-9000	Ø 400-P
L-E1-150	15,0	L-E1-150-3700	L-E1-150-4200	L-E1-150-4600	L-E1-150-5200	L-E1-150-6000	L-E1-150-7000	L-E1-150-8000	L-E1-150-9000	Ø 420-P
L-E1-185	18,5	L-E1-185-3700	L-E1-185-4200	L-E1-185-4600	L-E1-185-5200	L-E1-185-6000	L-E1-185-7000	L-E1-185-8000	L-E1-185-9000	Ø 440-P
L-E1-220	22,0	L-E1-220-3700	L-E1-220-4200	L-E1-220-4600	L-E1-220-5200	L-E1-220-6000	L-E1-220-7000	L-E1-220-8000	L-E1-220-9000	Ø 460-P

Available for all agitators:	Order no.
Slide-ring seal SIC with oil filling, extra charge on agitator	A-Preis-015
Oil filling, extra charge on agitator L-E-102	A-Preis-016
continuous drive shaft With PTO-shaft profile 1 3/8" for combination drive system (electric motor or tractor)	L-E1-DW

Assessories	Order no.
Sacrificial anode With galvanisierd holder	Z-Opferanode-01
Oil compression tank with holder	Z-Ölbehälter-02

Controller

For automatic interval switching, pre-installed, consisting of a right/left switch, an automatic star-delta connection, a repair switch, an emergency-off switch, a timer control and type A: an automatic star-delta connection or Typ B: automatic softstart

		A: Star-triangle circuit (Standard)	B: Soft start circuit
for a connected motor load of	7.5 kW	Steuerung-075	Steuerung-075-S
for a connected motor load of	11.0 kW	Steuerung-110	Steuerung-110-S
for a connected motor load of	15.0 kW	Steuerung-150	Steuerung-150-S
for a connected motor load of	18.5 kW	Steuerung-185	Steuerung-185-S
for a connected motor load of	22.0 kW	Steuerung-220	Steuerung-220-S

Controler Extra, digital timer, programmable	A-Preis-022	A-Preis-022
--	-------------	-------------



Electric mixer type Speed

Slurry slalom system:

The Speed range of slurry mixers is equipped with an electric drive and a V-belt gear reduction that is fitted with a belt tensioning system. The V-belt offers maximum protection for the drive motor and against breakage of the drive shaft should the mixing propeller become obstructed by a foreign object. 6-pole drive motors running at 1000 rpm are used for this mixer type. The high-torque electric motors allow for propeller speed ranges from 300-400 rpm, depending on the size. Thanks to the high torque, propeller diameters of 500-600 mm are possible.

Efficiency is far above that achieved by the standard electric motor, which runs at

1450 rpm. The mixer is supplied as standard with a pusher propeller but excluding switch and interval timer control. The mixer can be retrofitted with an angled drive making it suitable for virtually any application.

The three-part drive shaft is of a modular design. The upper and lower sections of the drive shaft are fitted with 2 taper roller bearings each, while the centre shaft section has a deep groove ball bearing. The maximum bearing spacing is 1500 mm.

An example:

A mixer with a length of 5200 mm has 7 bearings: 4 taper roller bearings and 3 radial bearings ensure safe, long-life operation.

The machine is of a very low maintenance design.

The bearing and drive systems correspond with those of the biogas mixer 1031 and are designed for continuous operation, 24/7, up to 1000 rpm.

The mixer is completely filled with oil. The drive shaft is sealed by means of a SiC/SiC mechanical seal. Oil level checks are carried out at the oil expansion tank which is installed to the side and which compensates for fluctuating oil volumes caused by varying temperatures.

The front drive shaft is equipped with a PTO spline in accordance with DIN 9611 which enables combined electric/tractor drive operation. If a tractor is used, the V-belts must be removed. The front drive shaft is sealed using a cartridge seal with 6 integrated sealing systems. The special seal is moisture proof. Air humidity and rain ingress are therefore no longer an issue.

Standard equipment of the mixer Type Speed:

- Mixer tube as seen on the 1031 biogas mixer design, with welded-on deflector ring and a lifting device.
- Propeller cage, square 625-625 or 700-700, depending upon motor rating. Other sizes on request.
- Motor cowling
- Oil filling
- Mechanical seal SiC/SiC
- Oil expansion tank
- 2 supports, matching the mixer base size
- Through shaft with PTO profile 1 3/8" Z6 DIN 9611 for combined use

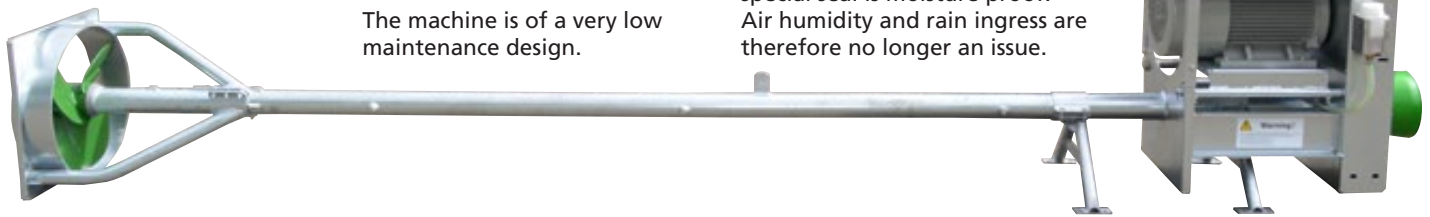

Mixer type	Motor-rating kW	3.200 mm Order no.	3.700 mm Order no.	4.200 mm Order no.	4.600 mm Order no.	5.200 mm Order no.	6.000 mm Order no.	Mixing propeller
Speed-055	5,5	Speed-055-3200	Speed-055-3700	Speed-055-4200	Speed-055-4600	Speed-055-5200	Speed-055-6000	Ø 460-Push
Speed-075	7,5	Speed-075-3200	Speed-075-3700	Speed-075-4200	Speed-075-4600	Speed-075-5200	Speed-075-6000	Ø 500-Push
Speed-110	11,0	Speed-110-3200	Speed-110-3700	Speed-110-4200	Speed-110-4600	Speed-110-5200	Speed-110-6000	Ø 560-Push
Speed-150	15,0	Speed-150-3200	Speed-150-3700	Speed-150-4200	Speed-150-4600	Speed-150-5200	Speed-150-6000	Ø 600-Push
Speed-185	18,5	Speed-185-3200	Speed-185-3700	Speed-185-4200	Speed-185-4600	Speed-185-5200	Speed-185-6000	Ø 600-Push
Speed-220	22,0	Speed-220-3200	Speed-220-3700	Speed-220-4200	Speed-220-4600	Speed-220-5200	Speed-220-6000	Ø 600-Push

Mixer type	Motor-rating kW	7.000 mm Order no.	8.000 mm Order no.	9.000 mm Order no.	10.000 mm Order no.	11.000 mm Order no.	12.000 mm Order no.	Mixing propeller
Speed-055	5,5	Speed-055-7000	Speed-055-8000	Speed-055-9000	Speed-055-10000	Speed-055-11000	Speed-055-12000	Ø 460-Push
Speed-075	7,5	Speed-075-7000	Speed-075-8000	Speed-075-9000	Speed-075-10000	Speed-075-11000	Speed-075-12000	Ø 500-Push
Speed-110	11,0	Speed-110-7000	Speed-110-8000	Speed-110-9000	Speed-110-10000	Speed-110-11000	Speed-110-12000	Ø 560-Push
Speed-150	15,0	Speed-150-7000	Speed-150-8000	Speed-150-9000	Speed-150-10000	Speed-150-11000	Speed-150-12000	Ø 600-Push
Speed-185	18,5	Speed-185-7000	Speed-185-8000	Speed-185-9000	Speed-185-10000	Speed-185-11000	Speed-185-12000	Ø 600-Push
Speed-220	22,0	Speed-220-7000	Speed-220-8000	Speed-220-9000	Speed-220-10000	Speed-220-11000	Speed-220-12000	Ø 600-Push

Zubehör	Order no.
Sacrificial anode With galvanised bracket	Z-Opferanode-01

Controller For automatic interval switching, pre-installed, consisting of a right/left switch, an automatic star-delta connection, a repair switch, an emergency-off switch, a timer control and type A: an automatic star-delta connection or Typ B: automatic softstart

	A: Star-triangle circuit (Standard)	B: Soft start circuit
for a connected motor load of 7.5 kW	Steuerung-075	Steuerung-075-S
for a connected motor load of 11.0 kW	Steuerung-110	Steuerung-110-S
for a connected motor load of 15.0 kW	Steuerung-150	Steuerung-150-S
for a connected motor load of 18.5 kW	Steuerung-185	Steuerung-185-S
for a connected motor load of 22.0 kW	Steuerung-220	Steuerung-220-S

Controller Extra,
digital timer, programmable

A-Preis-022

A-Preis-022

Installation box with guide rail

The installation box together with the double guide rail is designed to make the use of a mixer in a circulation system easier. Just a few minutes after the mixing process starts an intense circulation is set into motion because the slurry is unable to flow back to the front side of the propeller. The installation box is mounted at an angle to ensure that the slurry mixer never contacts the walls of deep channels but sits in the box, taking up the full channel width. Turning over or shifting is prevented due to the mixer being installed in the box.

Additional item:

Stainless steel anchor bolts for installation boxes. The box serves two main purposes: First as formwork and then a part supporting the guide rail.

This anchor bolt serves as an additional fastener for the guide rail. Costly formwork or masonry lintels are not required.

There are two systems designed to fasten the guide rails. For end face fastening, the basic wall attachment is adequate. If the guide rails are to be fastened laterally then two telescopic C profiles with large front plates are available for an adjustment range from 600 to 1200, either in galvanised or stainless steel versions.

The C1-76, C1-102, C/E1-102, E1-102, L-E1, Speed mixer ranges are recommended for the mixing system using an installation box and guide rail. They require a pivoting three point attachment or a bracket for the guide rail.

Recommendation:

Please observe the following slurry mixer and channel dimensions to ensure optimum efficiency:

- Overall depth 1900 mm = Mixer length 4200 mm
- Overall depth 2400 mm = Mixer length 5200 mm

- Overall depth 2800 mm = Mixer length 6000 mm
- Overall depth 3300 mm = Mixer length 7000 mm.

A pit must be planned in the vicinity of the mixer. It is also possible for the whole of the slurry channel in front of the mixer (slurry feed) to be made deeper in comparison with the other slurry channels.

The incline should be constructed approx. 1 m behind the mixer at an angle of max. 32° to the normal channel level.

If there are differing channel depths a stub dam (approx. 10 cm high) should be constructed at both ends of the less deep channels. If all channels are of the same depth and are not completely emptied, such a stub dam is not necessary.

Fitting the installation box with guide rail:

Place the box vertically on

the base plate and cover (sheathe) both sides. The box therefore provides a housing for the mixer which sits securely in a concrete partition wall. At the same time, the double angle bar is fixed in the box using 2 x M12 x 30 screws. Where shallow channels and short fermenter dumps are present, the minimum passage dimension of 0.64 m must be observed.

Very important:

Where deeper channels are present, the box must be encased in concrete 20-40 mm, at an angle. The limit is an insertion angle of 27.5°. Where the box is inserted at an angle of above 27.5° an appropriate base must be used underneath. Where encasing in concrete is required, the box must be stiffened using struts otherwise the compacting concrete might cause the box to bulge.

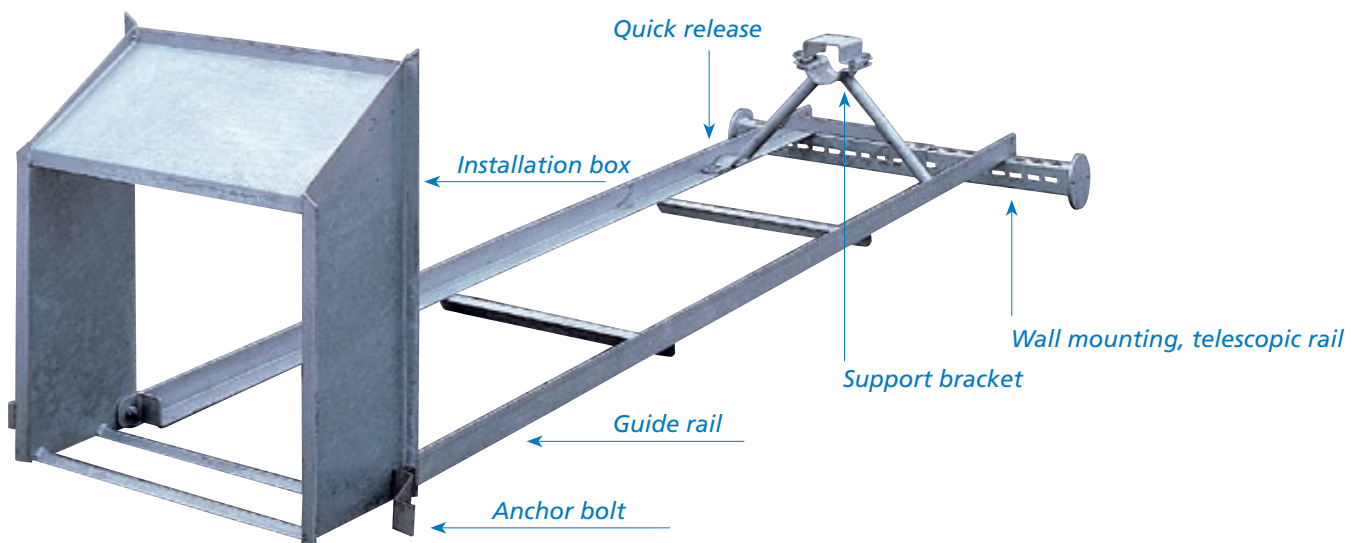

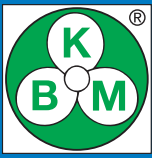

Installation box – Guide rails

Installation boxes – welded inclusive of 2 mounting screws for the guide rail

Size = internal width	Matches propeller cage	Galvanised version		Stainless steel version		
		Sheet thickness 3 mm	Sheet thickness 4 mm	Sheet thickness 2 mm	Sheet thickness 3 mm	Sheet thickness 4 mm
565 mm	540 x 540 mm	EBK-565-3-VS	EBK-565-4-VS	EBK-565-2-VA	EBK-565-3-VA	EBK-565-4-VA
625 mm	600 x 600 mm	EBK-625-3-VS	EBK-625-4-VS	EBK-625-2-VA	EBK-625-3-VA	EBK-625-4-VA
650 mm	625 x 625 mm	EBK-650-3-VS	EBK-650-4-VS	EBK-650-2-VA	EBK-650-3-VA	EBK-650-4-VA
725 mm	700 x 700 mm	EBK-725-3-VS	EBK-725-4-VS	EBK-725-2-VA	EBK-725-3-VA	EBK-725-4-VA
						These versions are supplied to order

Guide rails

for mixer bases 540-540, 600-600, 625-625, 700-700. Standard design is the 60-60-6 angle

- Universal mounting kit consisting of 50-50-5 angle and 60-60-6 angle
- Design fully welded 80-80-8 angle (to order)

Material	Profile	Lenght 4.000 mm	Lenght 5.000 mm	Lenght 6.000 mm	Lenght 7.000 mm	Lenght 8.000 mm	Lenght 9.000 mm
Galvanised steel	Winkel 50-50-5	GS-4000-VS-50-5	GS-5000-VS-50-5				
Galvanised steel	Winkel 60-60-6	GS-4000-VS-60-6	GS-5000-VS-60-6	GS-6000-VS-60-6			
Galvanised steel	Winkel 80-80-8	GS-4000-VS-80-8	GS-5000-VS-80-8	GS-6000-VS-80-8	GS-7000-VS-80-8	GS-8000-VS-80-8	GS-9000-VS-80-8
Stainless steel	Winkel 60-60-6	GS-4000-VA-60-6	GS-5000-VA-60-6	GS-6000-VA-60-6			
Stainless steel	Winkel 80-80-8	GS-4000-VA-80-8	GS-5000-VA-80-8	GS-6000-VA-80-8	GS-7000-VA-80-8	GS-8000-VA-80-8	GS-9000-VA-80-8

Accessories			
Anchor bolt		For stainless steel mounting box	Z-EBK-001
Galvanised wall mounting		For guide rail, basic version	Z-Wandb-001
Galvanised wall mounting		For guide rail, telescopic rails, for side mounting 600-1.200 mm	Z-Wandb-003
Galvanised wall mounting		For guide rail, telescopic rails, for side mounting 1.000-1.700 mm	Z-Wandb-006
Stainless steel wall mounting		For guide rail, basic version	Z-Wandb-002
Stainless steel wall mounting		For guide rail, telescopic rails, for side mounting 600-1.200 mm	Z-Wandb-005
Stainless steel wall mounting		For guide rail, telescopic rails, for side mounting 1.000-1.700 mm	Z-Wandb-007
Support bracket		Bracket for angle rail	Z-Halterung-001
Quick release		For mounting the angle rail, Stirring only permitted in suction mode	Z-Halterung-004

Installation box – two-part

The strength of this design lies in its ease of assembly.

The interior formwork matches the 200 mm standard concrete formwork and can easily be concreted in place.

The outside formwork is easily bolted in front of the interior formwork using machine bolts.

The outer formwork allows for an angle of incidence of up to 30° between guide rail and box and it is therefore an important component of this design.

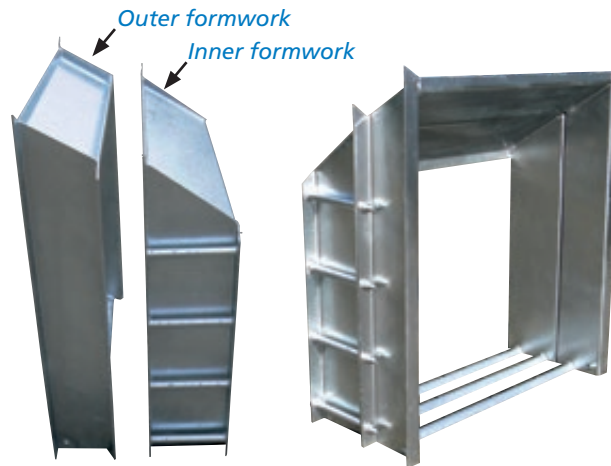

Standard version in galvanised steel

Size = internal width	Matches propeller cage	Galvanised steel sheet Sheet thickness 4 mm Complete kit	Galvanised steel sheet Sheet thickness 4 mm Inner formwork separate	Galvanised steel sheet Sheet thickness 4 mm Outer formwork separate
650 mm	625 x 625 mm	EBK-650-4-VS-SP-03	EBK-650-4-VS-SP-04	EBK-650-4-VS-SP-05
725 mm	700 x 700 mm	EBK-725-4-VS-SP-03	EBK-725-4-VS-SP-04	EBK-725-4-VS-SP-05

Stainless steel version (to order)

Size = internal width	Matches propeller cage	Stainless steel sheet Sheet thickness 4 mm Complete kit	Stainless steel sheet Sheet thickness 4 mm Inner formwork separate	Stainless steel sheet Sheet thickness 4 mm Outer formwork separate
650 mm	625 x 625 mm	EBK-650-4-VA-SP-03	EBK-650-4-VA-SP-04	EBK-650-4-VA-SP-05
725 mm	700 x 700 mm	EBK-725-4-VA-SP-03	EBK-725-4-VA-SP-04	EBK-725-4-VA-SP-05

Installation box – Guide rails

Installation box – that can be doweled in place



Fits into the partition wall

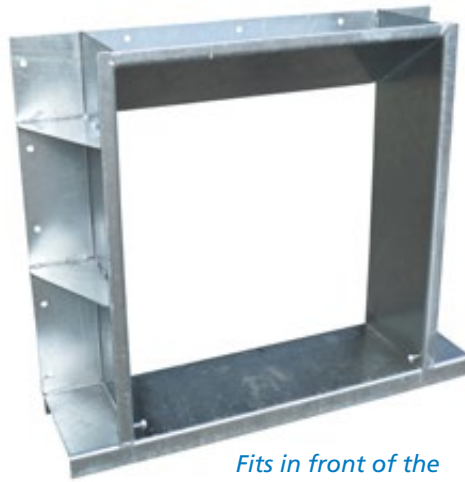

Fits in front of the partition wall

BUSCHMANN offers the following solutions for replacing corroded installation boxes in a circulation system:

- Special installation boxes that fit into existing openings
- Special installation boxes that fit in front of existing openings

These boxes are doweled onto the concrete wall without having to use a pneumatic drill. This makes the work flow considerably easier.

Installation box version for doweled in place	Size = Internal width	Matches propeller cage	Stainless steel version Sheet thickness 2 mm (Standard)	Stainless steel version Sheet thickness 4 mm (To order)	Galvanised version Sheet thickness 4 mm (Standard)
Fits into partition wall	650 mm	625 x 625 mm	EBK-650-2-VA-Sp-02	EBK-650-4-VA-Sp-02	EBK-650-4-VS-Sp-02
Fits into partition wall	725 mm	700 x 700 mm	EBK-725-2-VA-Sp-02	EBK-725-4-VA-Sp-02	EBK-725-4-VS-Sp-02
Fits in front of partition wall	650 mm	625 x 625 mm	EBK-650-2-VA-Sp-01	EBK-650-4-VA-Sp-01	EBK-650-4-VS-Sp-01
Fits in front of partition wall	725 mm	700 x 700 mm	EBK-725-2-VA-Sp-01	EBK-725-4-VA-Sp-01	EBK-725-4-VS-Sp-01

Guide rails – custom designs

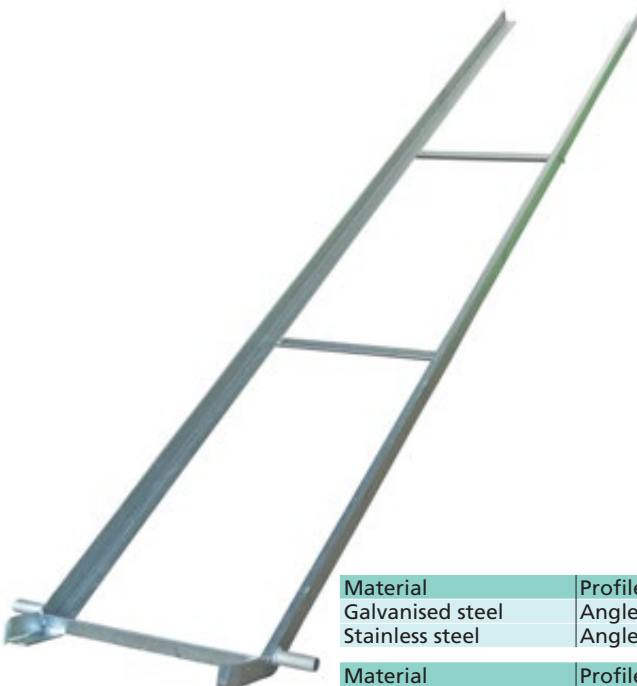

Where guide rails are rusted through, we can supply a custom solution as a replacement.

These guide rails have a transverse stop which makes a fixed point in front of the partition wall possible. Two extended guide brackets prevent the guide rail from slipping sideways as they lock in the opening. Old guide

rails can be replaced with this design, significantly reducing the workload. In order to guarantee safe use, the guide rail must be attached to the edge of the pit at the top.

Each rail size can be manufactured.

We need that 2 Information:

- The width of the agitator basket
- The agitator-wavelength

Fully welded construction.

Material	Profile	Lenght 4.000 mm	Lenght 5.000 mm	Lenght 6.000 mm
Galvanised steel	Angle 60-60-6	GS-4000-VS-SP-60-6	GS-5000-VS-SP-60-6	GS-6000-VS-SP-60-6
Stainless steel	Angle 60-60-6	GS-4000-VA-SP-60-6	GS-5000-VA-SP-60-6	GS-6000-VA-SP-60-6
Material	Profile	Lenght 4.000 mm	Lenght 5.000 mm	Lenght 6.000 mm
Galvanised steel	Angle 80-80-8	GS-4000-VS-SP-80-8	GS-5000-VS-SP-80-8	GS-6000-VS-SP-80-8
Material	Profile	Lenght 7.000 mm	Lenght 8.000 mm	Lenght 9.000 mm
Galvanised steel	Angle 80-80-8	GS-7000-VS-SP-80-8	GS-8000-VS-SP-80-8	GS-9000-VS-SP-80-8

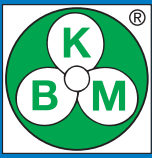

Accessories overview

Below you will find an overview of the complete accessory programme.
Column 3 refers to the page where you will find a detailed description of the item.

Accessory item	Order no.	Detail description	E-102	C/E-102	C/E-76	C-102	C-76	B-60	S-E2	L-E
Propeller suction	FL - *	Page 19	x	x	x	x	x	x		x
Propeller pusher	FL - *	Page 19	x	x	x				x	x
turbo suction	FL-Turbo- *	Page 19	x	x		x				
Turbo pusher	FL-Turbo- *	Page 19	x							
Folding propeller pusher	FL-Klappbar- *	Page 19	x	x						
Support bracket	Z-Halterung-001	Page 20	x	x	x	x	x	x		x
Universal instln. bracket	Z-Halterung-002	Page 20	x	x	x	x	x			x
Lower linkage mountain	Z-Halterung-003	Page 20	x	x	x	x	x	x		
Fixed installation bracket	Z-Halterung-007	Page 20	x	x		x				
Pivoting three point attachment	DB-sw - *	Page 23/24	x	x		x				
Fixed three point attachment	DB-st - *	Page 25	x	x	x	x	x	x		
Three point attachment extn.	DB-RV- *	Page 31	x	x		x				
Wheeled chas. - tube Ø 102	Z-Fahrwerk-004	Page 23	x	x		x				x
Propeller cage square	RWK - *	Page 18	x	x	x	x	x	x		x
Propeller cage round	RWK - *	Page 18	x	x		x				x
Hanging clamp	Z-Schelle-001	Page 18	x	x	x	x	x	x		
Reversing gearbox	Z-Getriebe-001	Page 21	x	x	x					
Angled drive	Z-Getriebe-002	Page 21	x	x	x					
T-gearbox	Z-Getriebe-003	—	x	x						
Sacrificial anode	Z-Opferanode- *	Page 22	x	x	x	x	x	x	x	x
Oil filling	A-Preis- *	Page 4	x						x	x
Oil expansion tank	Z-Ölbehälter- *	Page 22	x						x	x
Mechanical seal	A-Preis-015	Page 4	x						x	x
Skid standard	Kufe-001	Page 33	x	x	x	x	x	x		x
Skid reinforced	Kufe-002	Page 33	x	x		x				x
Skid + tyre bracket	Kufe-003	Page 33	x	x		x				x
Skid type S-E2	Kufe-004	Page 37							x	
Protective ring type S-E2	Z-Schutzring S-E2	Page 37							x	
Bracket tilting	Z-Halterung S-E2	Page 37							x	
Bracket tilting & pivoting	Z-Halterung S-E2 stationär	Page 37							x	
Hydraulic motor	Z-Hydraulikmotor-02	Page 35	x	x						
Pipe reinforcement	Z-U-*	Page 22	x	x		x				
Cage bracket	Z-Halterung-010	Page 20	x	x		x				



Longhorn length: 7000 mm
Mixer length: 9000 mm
Overall length: 16400 mm

Installation dimensions round Ø 720 mm

Installation dimensions for BUSCHMANN slurry mixers

Round propeller cage Ø 720 mm

(All dimensions in mm)

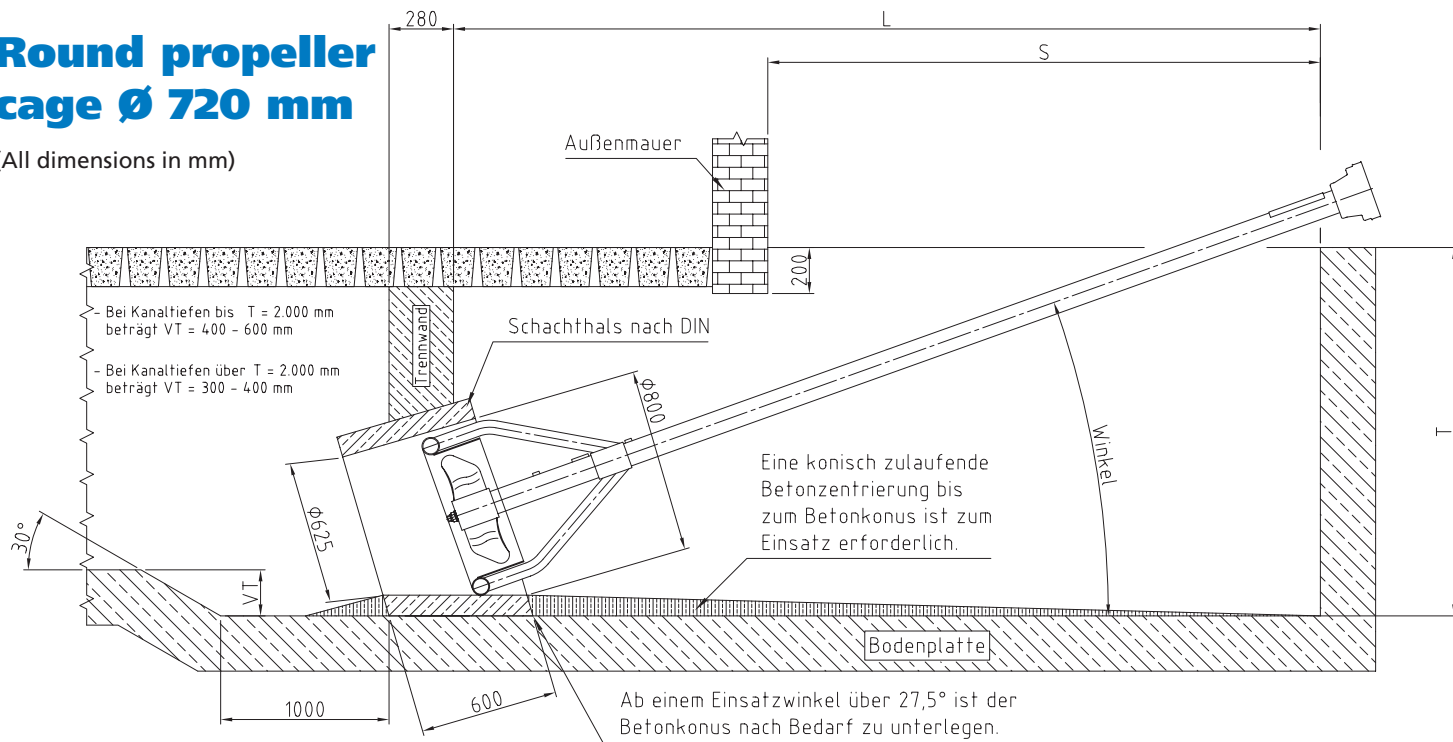

Shaft-depth (T)	Mixer length	Dimension (L)	Shaft-width	Pit opening (S)	Angle in degrees
1100	4200	3980	800	1800	12,5
1200	4200	3955	800	1800	14,0
1300	4200	3920	800	1800	15,5
1400	4200	3885	800	1800	17,0
1500	4200	3850	800	1800	18,5
1600	4200	3810	800	1800	20,0
1700	4200	3770	800	1800	21,5
1800	4200	3720	800	1800	23,0
1900	4200	3680	800	1800	25,0
2000	4200	3630	800	1800	26,0
2100	4200	3570	800	1800	28,0
2200	4200	3520	800	1800	30,0
2300	4200	3480	800	1800	31,6
2400	4200	3430	800	1800	33,2
2500	4200	3390	800	1800	34,8
2600	4200	3340	800	1800	36,5

Shaft-depth (T)	Mixer length	Dimension (L)	Shaft-width	Pit opening (S)	Angle in degrees
2200	6000	5490	800	2500	20,5
2300	6000	5430	800	2500	22,0
2400	6000	5400	800	2500	23,0
2500	6000	5345	800	2500	24,0
2600	6000	5300	800	2500	25,0
2700	6000	5265	800	2500	26,0
2800	6000	5205	800	2500	27,0
2900	6000	5140	800	2500	28,5
3000	6000	5080	800	2500	30,0
3100	6000	5015	800	2500	31,5
3200	6000	4950	800	2500	33,5
3300	6000	4885	800	2500	35,0
3400	6000	4820	800	2500	36,5
3500	6000	4755	800	2500	36,0
3600	6000	4690	800	2500	40,0
3700	6000	4655	800	2500	41,8

2000	5200	4720	800	2200	20,5
2100	5200	4680	800	2200	22,0
2200	5200	4640	800	2200	23,5
2300	5200	4590	800	2200	25,0
2400	5200	4535	800	2200	26,5
2500	5200	4508	800	2200	28,0
2600	5200	4420	800	2200	29,5
2700	5200	4380	800	2200	31,0
2800	5200	4340	800	2200	32,5
2900	5200	4280	800	2200	34,0
3000	5200	4220	800	2200	35,5
3100	5200	4180	800	2200	37,0
3200	5200	4120	800	2200	38,5
3300	5200	4070	800	2200	40,2
3400	5200	4030	800	1800	41,7

3000	7000	6204	800	2800	26,6
3100	7000	6154	800	2800	27,6
3200	7000	6103	800	2800	28,5
3300	7000	6049	800	2800	29,5
3400	7000	5994	800	2800	30,5
3500	7000	5936	800	2800	31,5
3600	7000	5882	800	2800	32,1
3700	7000	5827	800	2800	33,1
3800	7000	5769	800	2800	33,9
3900	7000	5709	800	2800	35,0
4000	7000	5707	800	2800	36,0
4100	7000	5582	800	2800	37,0
4200	7000	5515	800	2800	37,8
4300	7000	5445	800	2800	39,0
4400	7000	5373	800	2800	40,0

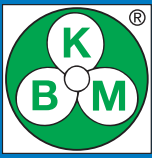

Installation dimensions 625 x 625 mm

Installation dimensions for BUSCHMANN slurry mixers

Propeller cage 625 x 625 mm

(All dimensions in mm)

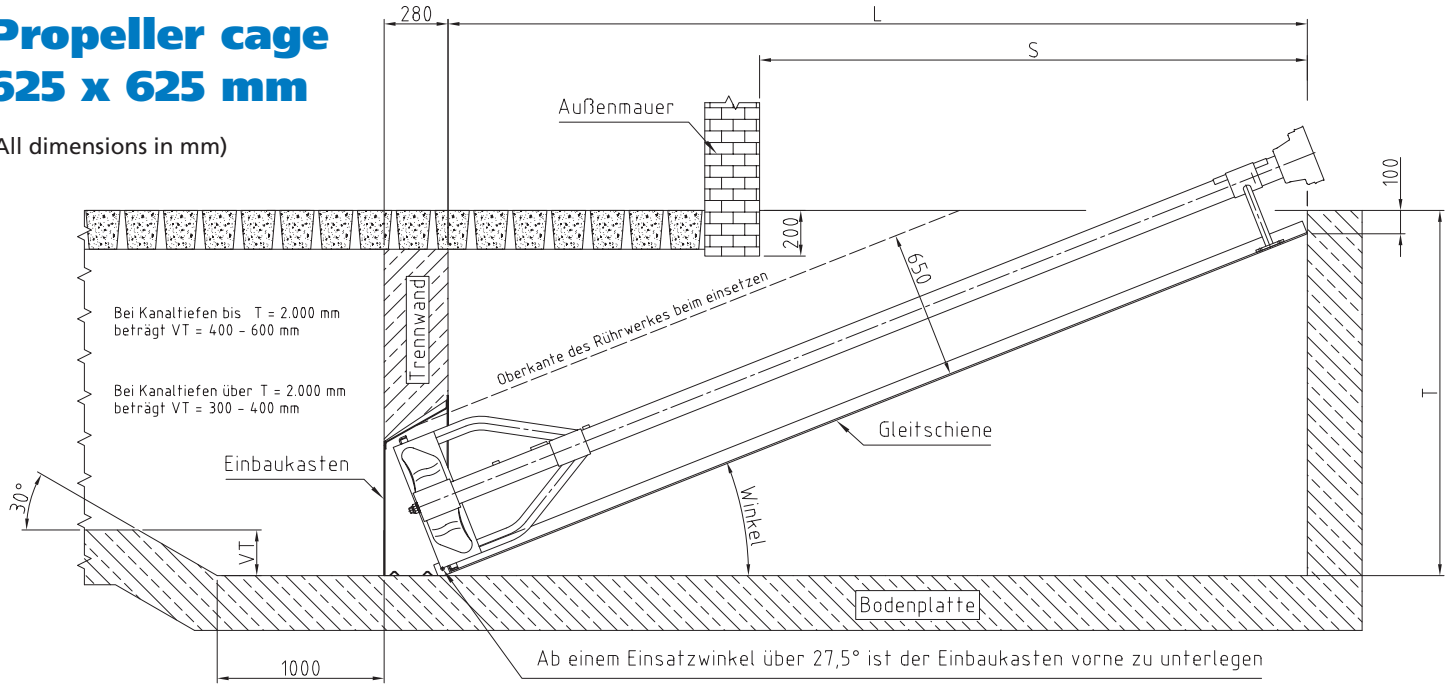

Shaft-depth (T)	Guide rail length (X)	Mixer length	Dimension (L)	Shaft-width	Pit opening (S)	Angle in degrees
1300	4000	4200	3816	800	2400	17,46°
1400	4000	4200	3783	800	2400	18,97°
1500	4000	4200	3747	800	2400	20,49°
1600	4000	4200	3708	800	2000	22,02°
1700	4000	4200	3666	800	2000	23,58°
1800	4000	4200	3621	800	1800	25,15°
1900	4000	4200	3572	800	1800	26,74°
2000	4000	4200	3520	800	1800	28,36°
2100	4000	4200	3464	800	1800	30,00°
2200	4000	4200	3404	800	1800	31,67°
2300	4000	4200	3341	800	1800	33,37°
2400	4000	4200	3273	800	1800	35,10°
2500	4000	4200	3200	800	1800	36,87°

Shaft-depth (T)	Guide rail length (X)	Mixer length	Dimension (L)	Shaft-width	Pit opening (S)	Angle in degrees
2000	6000	6000	5691	800	3000	18,46°
2100	6000	6000	5657	800	3000	19,47°
2200	6000	6000	5620	800	2400	20,49°
2300	6000	6000	5582	800	2400	21,51°
2400	6000	6000	5542	800	2400	22,54°
2500	6000	6000	5499	800	2400	23,58°
2600	6000	6000	5454	800	2400	24,62°
2700	6000	6000	5407	800	2400	25,68°
2800	6000	6000	5358	800	2400	26,74°
2900	6000	6000	5307	800	2400	27,82°
3000	6000	6000	5253	800	2400	28,90°
3100	6000	6000	5196	800	2400	30,00°
3200	6000	6000	5137	800	2400	31,11°
3300	6000	6000	5075	800	2400	32,23°
3400	6000	6000	5011	800	2400	33,37°
3500	6000	6000	4944	800	2400	34,52°
3600	6000	6000	4873	800	2400	35,69°

Shaft-depth (T)	Guide rail length (X)	Mixer length	Dimension (L)	Shaft-width	Pit opening (S)	Angle in degrees
1500	5000	5200	4800	800	2800	16,26°
1600	5000	5200	4770	800	2800	17,46°
1700	5000	5200	4737	800	2800	18,66°
1800	5000	5200	4702	800	2800	19,88°
1900	5000	5200	4665	800	2200	21,10°
2000	5000	5200	4625	800	2200	22,33°
2100	5000	5200	4583	800	2200	23,58°
2200	5000	5200	4538	800	2200	24,83°
2300	5000	5200	4490	800	1800	26,10°
2400	5000	5200	4440	800	1800	27,39°
2500	5000	5200	4386	800	1800	28,69°
2600	5000	5200	4330	800	1800	30,00°
2700	5000	5200	4271	800	1800	31,33°
2800	5000	5200	4208	800	1800	32,68°
2900	5000	5200	4142	800	1800	34,06°
3000	5000	5200	4073	800	1800	35,45°
3100	5000	5200	4000	800	1800	36,87°

Shaft-depth (T)	Guide rail length (X)	Mixer length	Dimension (L)	Shaft-width	Pit opening (S)	Angle in degrees
2500	7000	7000	6576	800	2800	20,05°
2600	7000	7000	6538	800	2800	20,92°
2700	7000	7000	6499	800	2800	21,80°
2800	7000	4200	6458	800	2800	22,69°
2900	7000	7000	6416	800	2800	23,58°
3000	7000	7000	6371	800	2800	24,47°
3100	7000	7000	6325	800	2800	25,38°
3200	7000	7000	6276	800	2800	26,29°
3300	7000	7000	6226	800	2800	27,20°
3400	7000	7000	6173	800	2800	28,13°
3500	7000	7000	6119	800	2800	29,06°
3600	7000	7000	6062	800	2800	30,00°
3700	7000	7000	6003	800	2800	30,95°
3800	7000	7000	5942	800	2800	31,91°
3900	7000	7000	5879	800	2800	32,88°
4000	7000	7000	5813	800	2800	33,86°
4100	7000	7000	5745	800	2800	34,85°

Installation dimensions for slurry mixers

Installation dimensions of Buschmann slurry mixers

Propeller cage 625 x 625 mm	Propeller cage 700 x 700 mm	Propeller cage 800 x 800 mm
Installation angle 15° Pit opening min. 2.800 mm	Pit opening min. 3.400 mm	Pit opening min. 3.800 mm
Installation angle 20° Pit opening min. 2.200 mm	Pit opening min. 2.700 mm	Pit opening min. 2.900 mm
Installation angle 25° Pit opening min. 1.800 mm	Pit opening min. 2.200 mm	Pit opening min. 2.400 mm

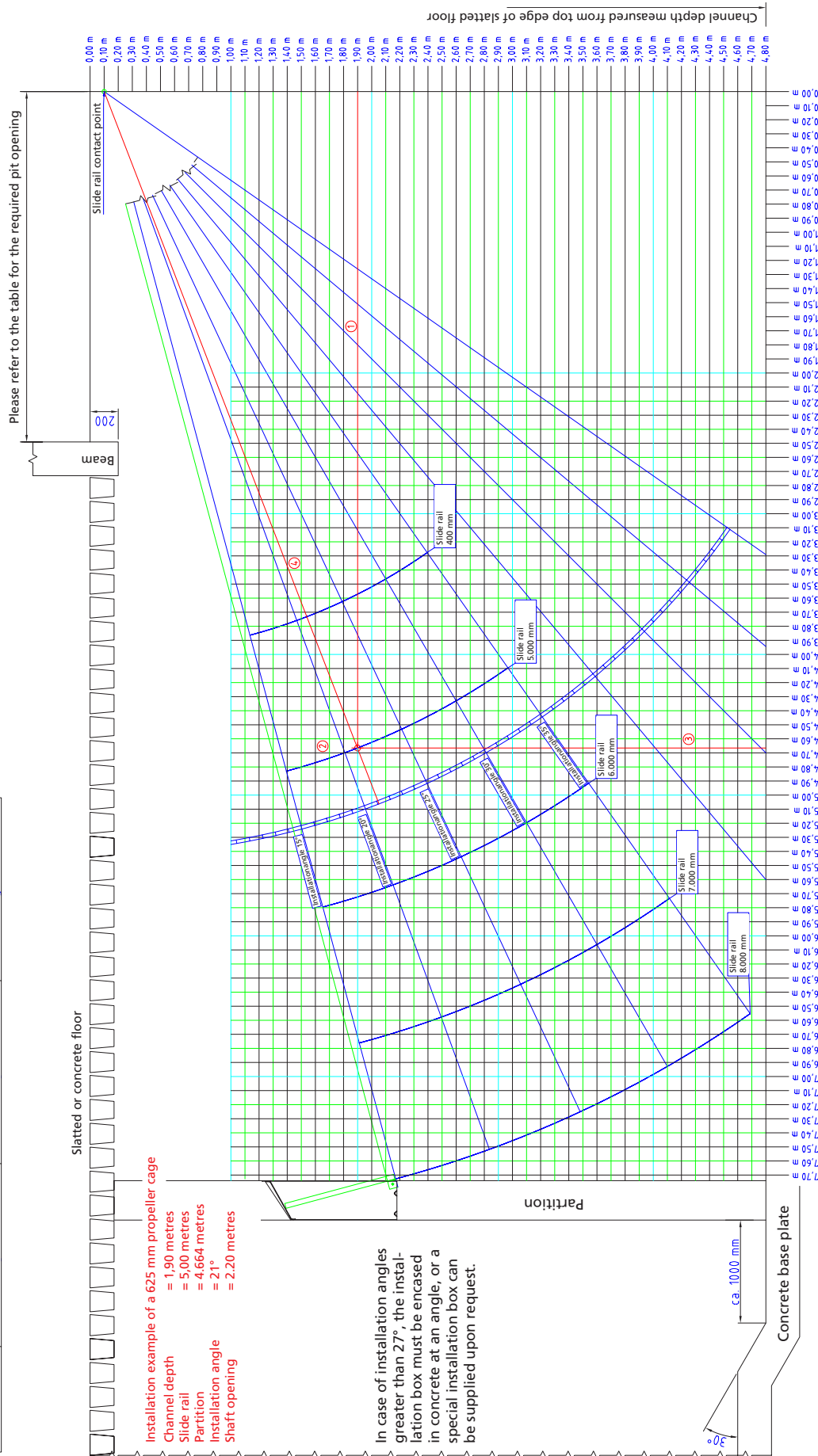

Installation example of a 625 mm propeller cage
 Channel depth = 1,90 metres
 Slide rail = 5,00 metres
 Partition = 4,664 metres
 Installation angle = 21°
 Shaft opening = 2,20 metres

In case of installation angles greater than 27°, the installation box must be encased in concrete at an angle, or a special installation box can be supplied upon request.

1. Draw in channel depth (draw a line)
2. Select slide rail length
3. Draw a vertical line at the intersection point of the slide rail/channel depth
4. Draw a line upwards from the intersection point of the channel depth/slide rail to the slide rail contact point
5. The installation angle and the partition dimensions can now be read off precisely
6. The required pit opening can now be determined via the installation angle



Forced circulation systems

Installation instructions for the concrete cone:

An aperture of 1.0 x 1.0 m is required in the partition wall. The dimension "L" shall be maintained to the same depth as the channel as far as the slatted floor. Once the partition wall has been completed the concrete cone shall be bricked-in in accordance with the mixer that is to be installed.

From the inner edge of the concrete cone, the centring concrete plinth must be continuously poured as far as the inner edge of the preliminary trough so that it forms a cone. This centring concrete plinth is used to exactly direct the mixer to be used into the opening of the concrete cone ready for operation. If the channel is not deep and the pre-liminary trough short, it is essential that the minimum clearance of 0.72 m is maintained.

Very important:

In the case of deeper channels, the concrete cone shall be constructed on an angle at 50-100 mm. The limit is the operating angle of 27.5°. Above an operating angle of 27.5° the concrete cone must be correspondingly supported so that the propeller cage seals properly.

Different forced circulation systems are in use. Where the concrete cone is used, the costs for the installation box and guide rail do not arise. On the other hand however, there are considerable costs for concreting work.

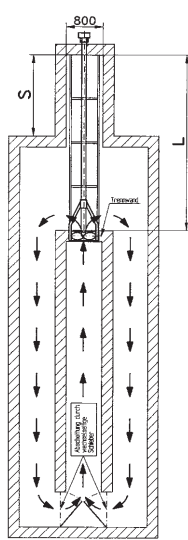

3-channel

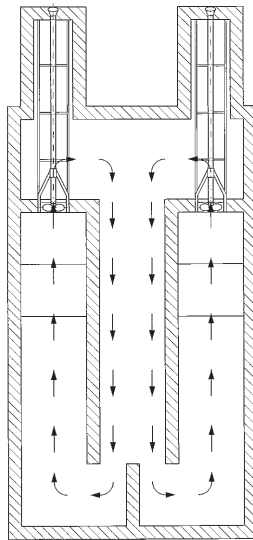

2-channel

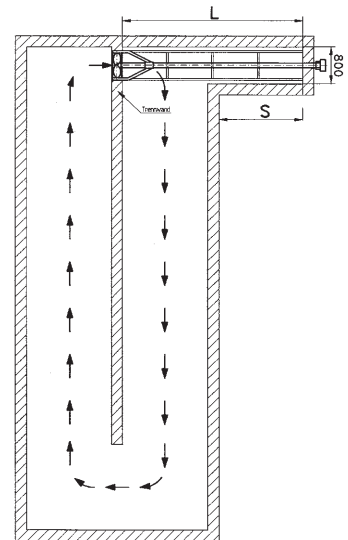
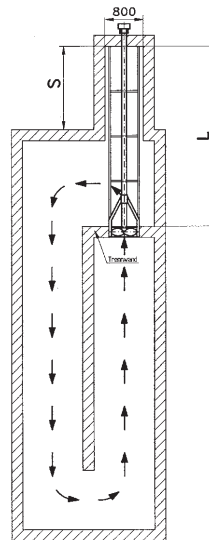

Recommendation

Please observe the following slurry mixer and channel dimensions to ensure optimum efficiency:

- Overall depth 1900 mm = Mixer length 4200 mm
- Overall depth 2400 mm = Mixer length 5200 mm
- Overall depth 2800 mm = Mixer length 6000 mm
- Overall depth 3300 mm = Mixer length 7000 mm.

In the mixing system with the concrete cone it should be planned to use the mixer ranges: C1-102, C/E1-102, E1-102.

These require a swivelling three point linkage to be fitted to the mixer. The bracket for the angled rail is not used in systems with the concrete cone. Permanent installation of the mixer is difficult because there is no angled

rail to which the bracket for the angled rail can be bolted. During axial alternating operation it is very difficult to absorb the forces that arise without the three point attachment. To counteract the torsional forces that arise during operation with a reversing gearbox, it is absolutely essential that the swivelling three point attachment is fitted.

An arrester cable (to limit the degree of swivel) and hydraulic height adjustment have proven useful for such operations.

Constant velocity drive shaft

A constantly recurring issue regarding the drive system for slurry mixers is the selection of a suitable drive shaft. The type of drive shaft is defined by the power that has to be transmitted and the degree of angling when the mixer is in operation. While the power requirement can be measured and normally lies within the 55 - 75 kW range (depending upon the propeller blade diameter and speed of rotation), determination of the angling is, depending upon the specific application, not so straightforward. This is because the angle between the tractor and the mixer changes constantly during operation. This may be caused by leaking tractor hydraulics (internal leaks), by moving the tractor, through different operating heights, through vibrations and through the changing consistency of the slurry.

The correct drive shaft must be determined taking these conditions into consideration.

1. Standard drive shaft

A standard drive shaft is characterised by irregular rotation when it is angled. The undesired consequences that result from this, such as vibrations, noises and alternating loads, become worse as the speed and rotating masses increase. Eventually, this will lead to the destruction of the drive shaft, the machine itself and the power take-off shaft of the tractor. The torsional vibrations that this generates limit the extent of the angling of the joints to $2 \times 10^\circ$. It is possible to counteract this if both angles are the same and if they cancel each other out. Because it is impossible to fulfil these conditions it is not, in accordance with the explanations above, using a standard drive shaft is not recommended.

2. Single-sided wide-angle drive shaft

The use of a single-sided wide-angle drive shaft places certain requirements on the way in which it is used. The universal joint should be kept as straight as possible so that serious torsional vibrations do not arise in this joint. Slight angling of up to 12° at 540 rpm, to 5° at 1000 rpm is permissible. The large angle is bridged by the wide-angle constant velocity joint. This ensures that the drive shaft, tractor and mixer are not damaged during operation, even if the angle changes autonomously. The angle of the universal joint must however be regularly checked, and re-adjusted if necessary. The wide-angle constant velocity joint may only be allowed to operate at a large angle for a short period of time.

3. Double-sided wide-angle drive shaft

If the conditions for the use of a single-sided wide-angle drive shaft cannot be fulfilled, then the use of a wide-angle drive shaft on both sides is necessary.

All drive shafts comply with the latest quality and safety regulations.

The high torque transmission in the same position and the usually aggressive environmental conditions make it imperative to regularly grease the drive shaft at short intervals.

Observe the separate user instructions from Buschmann in addition to the operating instructions from the drive shaft manufacturer.

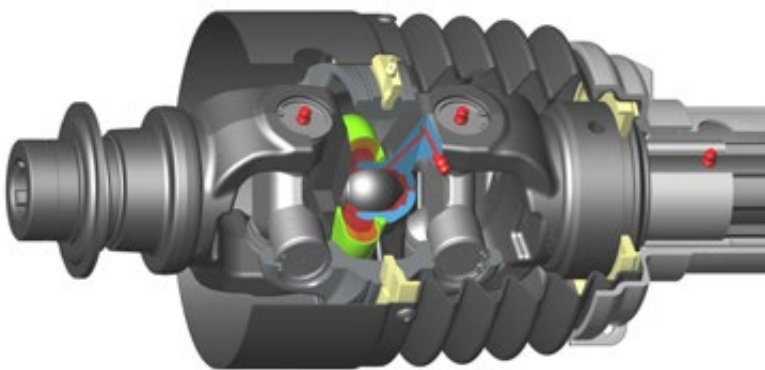

The patented 50° wide-angle universal joint exhibits less wear in comparison with an 80° wide-angle universal joint, even under conditions of latent permanent angling.

The patented 50° wide-angle universal joint

Strong, single or double-sided wide-angle drive shafts with the patented 50° wide-angle universal joint are available now. The perfect interplay of ball and ball head result in much lower wear than with conventional 80° wide-angle joints fitted with control discs. In the case of permanent angling in particular, these drive shafts offer the advantage of working without the sensitive control disc.

Article	Wide-angle	Type	Total length L. min.	Cross/cross L. min.	Connection DIN 9611	Power limit 1.000 1/min.
G-06	double-sided 50°	CS8R 086 CE KR7 KR7	1.334 mm	860 mm	1 3/8 inch Z6	100 kW (136 PS)
G-07	single 50°	CS8R 086 CE KR7 007	1.219 mm	860 mm	1 3/8 inch Z6	100 kW (136 PS)
G-08	without	CS8N 086 CE 007 007	1.110 mm	860 mm	1 3/8 inch Z6	100 kW (136 PS)
G-09	double-sided 50°	CSHR 086 CE KR7 KR7	1.346 mm	860 mm	1 3/8 inch Z6	147 kW (200 PS)
G-10	single 50°	CSHR 086 CE KR7 R07	1.247 mm	860 mm	1 3/8 inch Z6	147 kW (200 PS)

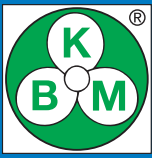

Additional items propeller cages and clamps

Propeller cages

for mixer types B1-60, C1-76, C1-102, C/E1-76, C/E1-102, C/E1-76, E1-102

Propeller cages: Size = External dimensions, square					
Outer tube	450 x 450 mm	500 x 500 mm	540 x 540 mm	600 x 600 mm	625 x 625 mm
Ø 60 mm	Internal Ø 415 mm	Internal Ø 465 mm	Internal Ø 505 mm	Internal Ø 565 mm	Internal Ø 590 mm
Ø 76 mm	RWK-001	RWK-004	RWK-006	RWK-008	RWK-010
Ø 102 mm	RWK-002	RWK-005	RWK-007	RWK-009	RWK-011
Outer tube	680 x 680 mm	690 x 690 mm	690 x 690 mm	700 x 700 mm	700 x 700 mm
Ø 76 mm	Internal Ø 590 mm	Internal Ø 590 mm	Internal Ø 650 mm	Internal Ø 590 mm	Internal Ø 650 mm
Ø 102 mm	RWK-020	RWK-022	RWK-024	RWK-012	RWK-014
	RWK-021	RWK-023	RWK-025	RWK-013	RWK-015

All custom sizes are available at short notice.

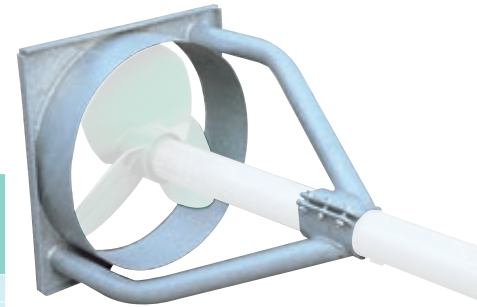

Square propeller cage

Propeller cages, round design

For use in concrete cones To fit mixer types C1-102, C/E1-102, E1-102

BUSCHMANN-Standard

Size:	Ø 720 mm
Outside tube:	Ø-2"
Guide plate width:	160 mm
Supporting tubes:	2" thick-walled
Propeller passage hole:	Ø 590 mm
Pipe clamp:	Ø 102 x 150 x 8 mm

Propeller cages, round design:

Ø 720 x Ø 590	RWK-016
Ø 780 x Ø 650	RWK-017
Ø 920 x Ø 650	RWK-018
Ø 920 x Ø 790	RWK-019

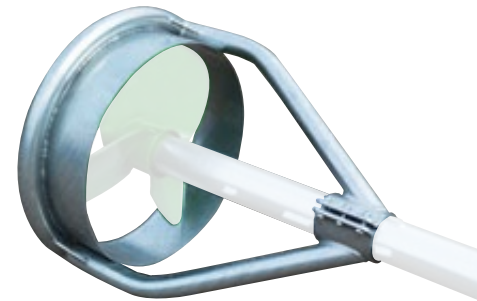

Round propeller cage



Hanging clamp

galvanized, for transportation with a front loader.

Available for tube Ø 60-; Ø 76- and Ø 102 mm

Order no.: Z-Schelle-001

Clamp range

Whether for use in slurry or stall systems, BUSCHMANN has the right solution for many fastening problems. Designs that are not listed in the table can be manufactured for you upon request.

Size outside tube Ø	Clamp-length	Clamp-gauge	Optional	Half clamp in black	Half clamp galvanised	Half clamp stainless steel
101,60 mm	150 mm	8 mm	Standard	HBS-102-150-8-sw	HBS-102-150-8-vs	HBS-102-150-8-V2A
76,10 mm	150 mm	8 mm	Standard	HBS- 76-150-8-sw	HBS- 76-150-8-vs	HBS- 76-150-8-V2A
101,60 mm	400 mm	5 mm	Standard	HBS-102-400-5-sw	HBS-102-400-5-vs	HBS-102-400-5-V2A
101,60 mm	150 mm	5 mm	Standard	HBS-102-150-5-sw	HBS-102-150-5-vs	HBS-102-150-5-V2A
101,60 mm	130 mm	5 mm	Standard	HBS-102-130-5-sw	HBS-102-130-5-vs	HBS-102-130-5-V2A
101,60 mm	50 mm	5 mm	Standard	HBS-102- 50-5-sw	HBS-102- 50-5-vs	HBS-102- 50-5-V2A
76,10 mm	150 mm	5 mm	Standard	HBS- 76-150-5-sw	HBS- 76-150-5-vs	HBS- 76-150-5-V2A
76,10 mm	130 mm	5 mm	Standard	HBS- 76-130-5-sw	HBS- 76-130-5-vs	HBS- 76-130-5-V2A
76,10 mm	50 mm	5 mm	Standard	HBS- 76- 50-5-sw	HBS- 76- 50-5-vs	HBS- 76- 50-5-V2A
60,30 mm	150 mm	5 mm	Standard	HBS- 60-150-5-sw	HBS- 60-150-5-vs	HBS- 60-150-5-V2A
60,30 mm	130 mm	5 mm	Standard	HBS- 60-130-5-sw	HBS- 60-130-5-vs	HBS- 60-130-5-V2A
60,30 mm	50 mm	5 mm	Standard	HBS- 60- 50-5-sw	HBS- 60- 50-5-vs	HBS- 60- 50-5-V2A

Additional items for mixing propellers

Thanks to their dynamic shape, our mixing propellers ensure the maximum efficiency of your slurry system. Balanced mixing blades ensure smooth running.



Standard mixing propeller

- All-round propeller for any application
 - Ensures high efficiency even in reverse operation
- Options available are
1) suction or
2) pusher.
The propeller is made of painted steel or stainless steel.

Standard mixing propeller diameters:

Ø 560 mm und Ø 600 mm

Other sizes:

Ø 220 mm to Ø 600 mm available at short notice, above Ø 600 mm made to order.

Slurry mixer propeller capacity and power requirements

The power requirements have been measured under extreme conditions. Under normal conditions, approx. 10% less power is required

Mixing propeller	Power req. in hp	Power req. in kW	Speed 1/min.	Mix capacity cbm/hr.	Mixer type	Propeller painted Order no.	Prop. stainless steel Order no.
Ø 600 mm	92,0	67,64	540	3.845	E-102	FL-600-E-St	FL-600-E-VA
Ø 560 mm	80,0	58,82	540	3.352	E-102	FL-560-E-St	FL-560-E-VA
Ø 540 mm	74,0	54,41	540	3.118	E-102	FL-540-E-St	FL-540-E-VA
Ø 520 mm	70,0	51,47	540	2.888	E-102	FL-520-E-St	FL-520-E-VA
Ø 500 mm	60,0	44,11	540	2.673	E-102	FL-500-E-St	FL-500-E-VA
Ø 480 mm	50,0	36,76	540	2.464	E-102	FL-480-E-St	FL-480-E-VA
Ø 460 mm	46,0	33,82	540	2.260	E-102	FL-460-E-St	FL-460-E-VA
Ø 460 mm	30,0	22,00	516	2.150	L-E1	FL-460-LE-St	FL-460-LE-VA
Ø 440 mm	25,0	18,50	516	1.795	L-E1	FL-440-LE-St	FL-440-LE-VA
Ø 420 mm	20,0	15,00	516	1.620	L-E1	FL-420-LE-St	FL-420-LE-VA
Ø 400 mm	15,0	11,00	516	1.452	L-E1	FL-400-LE-St	FL-400-LE-VA
Ø 380 mm	10,0	7,50	516	1.293	L-E1	FL-380-LE-St	FL-380-LE-VA
Ø 360 mm	7,5	5,50	516	1.150	L-E1	FL-360-LE-St	FL-360-LE-VA
Ø 340 mm	5,5	4,00	516	999	L-E1	FL-340-LE-St	FL-340-LE-VA
Ø 380 mm	15,0	11,00	540	1.145	B-60	FL-380-B-St	FL-380-B-VA
Ø 350 mm	20,0	15,00	1.450	859	S-E2	FL-350-SE-St	FL-350-SE-VA
Ø 320 mm	15,0	11,00	1.450	708	S-E2	FL-320-SE-St	FL-320-SE-VA
Ø 280 mm	10,0	7,50	1.450	528	S-E2	FL-280-SE-St	FL-280-SE-VA
Ø 250 mm	7,5	5,50	1.450	408	S-E2	FL-250-SE-St	FL-250-SE-VA
Ø 220 mm	5,5	4,00	1.450	302	S-E2	FL-220-SE-St	FL-220-SE-VA

Please state whether you require a suction or pusher propeller and the mixer type when ordering.

Turbo propeller



The shape of the Turbo mixing propeller ensures maximum performance. The concentrated agitation jet allows for maximum deep mixing. The Turbo mixing propeller is well suited for open slurry systems.

As a result of its design, the Turbo mixing propeller achieves optimum efficiency in one flow direction only. Operation with a reversing box is not recommended because the propeller does not achieve any mixing capacity in reverse operation.

The Turbo mixing propeller can be ordered in all blade sizes, optionally as a suction or pusher propeller.

Turbo mixing propellers are available in painted and stainless steel versions.

Standard mixing propeller diameters:

Ø 560 mm and Ø 600 mm

Other sizes: On request

Ø mm	Painted propeller	Stainless steel prop.
560	FL-Turbo-560-St	FI-Turbo-560-VA
600	FL-Turbo-600-St	FI-Turbo-600-VA

Folding propeller



For narrow access holes from an internal diameter of 250 mm, the folding propeller provides an optimum method of slurry mixing.

The folding propeller automatically opens as a result of resistance from the slurry and is only pushing to this use and only suitable for one rotational direction.

Folding mixing propellers are available in painted and stainless steel versions.

Standard mixing propeller diameter:

Ø 500 mm (open)

Ø mm	Painted propeller	Stainless steel prop.
500	FL-klappbar-500-St	FI-klappbar-500-VA

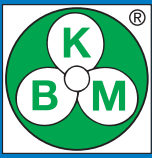

Support bracket

Bracket for the angled rail in the slurry cellar. Please indicate the width of the agitator basket and the diameter of the pipe in case of subsequent delivery.

Standard width: 540-600-625-700 (mm)

Version in galvanized.

Available for tube Ø 60-; Ø 76- and Ø 102 mm

Order no.: Z-Halterung-001



Universal mixer installation bracket

Adjustment range 600 - 1200 mm standard model

Adjustment range 1000 - 1700 mm enhanced version

Angle 0 – 180 degrees.

Use: In forced circulation systems only with installation boxes or concrete cone. Version in galvanized. Available for tube Ø 76- and Ø 102 mm

Order no.: Standard model Z-Halterung-002

Order no.: Enhanced version Z-Halterung-008

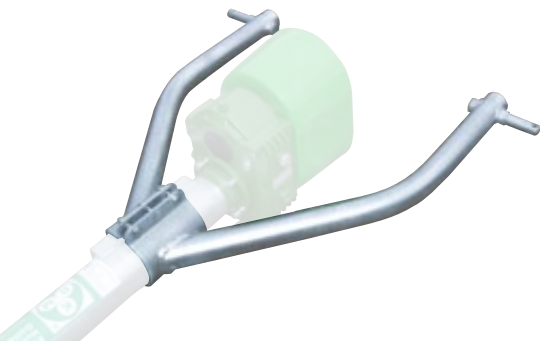

Lower linkage mounting

In place of a bracket for the angled rail or a three point attachment.

It is recommended that Hanging clamps are used with this mounting.

Only permitted in combination with an agitator cage or a reinforced skid.

Version in galvanized. Available for tube Ø 60-; Ø 76- and Ø 102 mm

Lower linkage mounting, complete:

Order no.: Z-Halterung-003

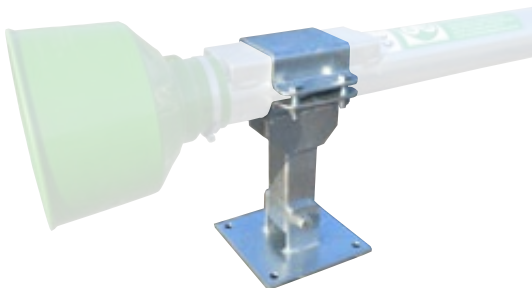

Fixed installation bracket

Bracket for fixed installation on the baseplate at the edge of the pit or on the preliminary trough bulkhead.

Angle 0 – 180 degrees.

Galvanized, fits Ø 102 mm tube:

Order no.: Z-Halterung-007



Cage bracket

Fastening profile for the agitator cage, dimensions 700 x 700, for dowelling on a concrete slab.

Galvanized version, without ground anchor:

Order no.: Z-Halterung-010

Accessories



Reversing gearbox Standard

Scope of delivery:
This retrofit kit includes a gearbox flange, the reversing gearbox, a protective cone and the required bolts.

The use of a reversing gearbox is limited to the mixer types C/E-76, C/E-102 and E-102.

We recommend that this is only fitted where type E-102 bearing technology is employed.

2 x PTO connection
1 3/8" Z6 DIN 9611,
ratio 1:1, only to change
the direction of rotation

Order no.: Z-Getriebe-001



Heavy duty reversing gearbox

The heavy duty reversing gearbox is designed for up to 40% higher power transmission. The scope of supply and the recommendations for use correspond to the standard version.

2 x PTO connection
1 3/8" Z6 DIN 9611,
ratio 1:1, only to change
the direction of rotation

Order no.: Z-Getriebe-004



Angular gear

It can be mounted to agitator types C-102, C/E-76, C/E-102 and E-102. The angled drive is available in a standard and a heavy duty version for up to 66% higher power

transmission compared with the standard version. There is no change in the direction of rotation of the agitator blades or the speed.

Order no: standard model Z-Getriebe-002

Order no: enhanced version Z-Getriebe-005



Universal mount for speed agitators

The bracket is screwed under the V-belt box. The two side stands are attached to a concrete slab. Unique feature: the height and angle of the bracket is adjustable.

Order no.: Z-Halterung-009



Pipe reinforcement

individually manufactured after consultation.
Available for outer pipe Ø 102 mm.
Galvanised finish.

Mixer shaft length	Item number
4.200 mm	Z-U-4200-vs
4.600 mm	Z-U-4600-vs
5.200 mm	Z-U-5200-vs
6.000 mm	Z-U-6000-vs

Sacrificial anode

Pure slurry has a normal pH value. Using concrete additives, claw care products, cleaning agents, copper sulphates, fertilisers, silage additives and so on has a negative impact on the pH value in the slurry. This can result in the zinc layer of all

parts being corroded and destroyed (electro-chemical corrosion).

To counteract this we recommend the use of a sacrificial anode.

Available items:

Z-Opferanode-01
With galvanised bracket

Z-Opferanode-02
With stainless steel bracket

Oil expansion tank

The oil expansion tank has four functions:

- It compensates for the oil level fluctuating due to temperature changes.
- It is used for checking the oil level.

- It ensures the necessary pressure compensation in the mixer tube.
- It facilitates optimum lubrication of the front seal in mixers that are installed on the floor

angle plane.

Important:
The oil expansion tank must always be installed at the highest point.

Tank set with bracket and clamp set for mounting on the mixer pipe

Typ	Volume	Outer pipe	Item no.:
PVC tank	01 litre	Ø 102 mm	Z-Oil tank-01
Stainless steel tank	02 litres	Ø 102 mm	Z-Oil tank-03
Stainless steel tank	06 litres	Ø 102 mm	Z-Oil tank-05
Stainless steel tank	06 litres	Ø 168 mm	Z-Oil tank-07
Stainless steel tank	12 litres	Ø 168 mm	Z-Oil tank-09

Tank set with bracket for mounting on the mixer frame, or for stationary mounting on a wall

Typ	Volume	Order no.:
PVC tank	01 litre	Z-Oil tank-02
Stainless steel tank	02 litres	Z-Oil tank-04
Stainless steel tank	06 litres	Z-Oil tank-06
Stainless steel tank	12 litres	Z-Oil tank-08



All oil expansion tanks are supplied with hose and fittings, without oil and without wall anchors (version for wall mounting).

Pivoting three point attachment

The slurry mixers are to be used with a pivoting three point attachment. Its length shall correspond with that of the mixer.

The use of a pivoting three point attachment is only possible with slurry mixers that have an external tube diameter of 102 mm.

The pivoting attachment allows the mixer to be used easily even with the smallest of pit openings.

Pivoting three point attachment with adjustment spindle*

Lowering the mixer to the different operating positions is achieved through the tractor's hydraulic system or the adjustment spindle. For pit openings of over 600 x 700 mm we recommend

the normal pivoting three point attachment with adjustment spindle. The advantage of this adjustment spindle is that the universal joints on the driveshaft can be optimally balanced in this way. In

place of the adjustment spindle a hydraulic height adjustment mechanism can also be installed. This makes the system far easier to use.

Galvanised tree point mounting with adjustment spindle and pivot. Can only be used with mixers that have an external tube diameter of 102 mm.

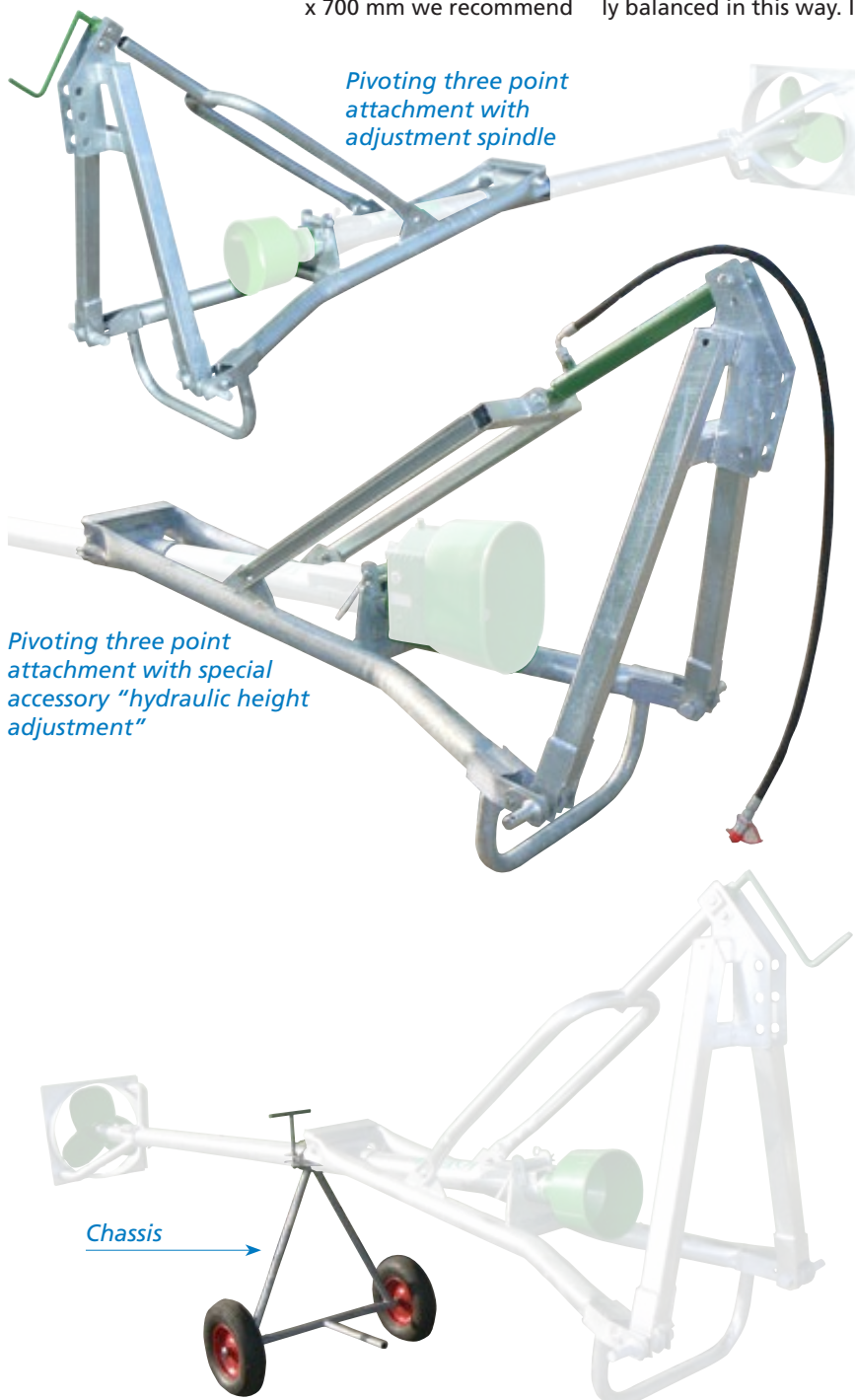

Pivoting three point attachment with adjustment spindle

Pivoting three point attachment with special accessory "hydraulic height adjustment"

Chassis

For slurry mixers	Order no.:
– Up to 4500 mm overall length	DB-sw-4500-Sp
– Up to 5500 mm overall length	DB-sw-5500-Sp
– Up to 6200 mm overall length	DB-sw-6200-Sp
Pivot limiter cable	DB-Seil-01

Special equipment:	Order no.:
Retrofit kit for hydraulic height adjustment	
– For mixers up to 5500 mm	DB-Hy-U-01
– For mixers up to 6200 mm	DB-Hy-U-02
Throttle valve for hydraulic cylinder	Z-Drosselventil-01

Price supplements	Order no.:
For new deliveries, in place of the adjustment spindle	
– For mixers up to 5500 mm	DB-Hy-A-01
– For mixers up to 6200 mm	DB-Hy-A-02

* The agitator is not included in the scope of supply

Wheeled chassis for slurry mixers

Using this wheeled chassis, PTO mixers with fitted three point attachment may easily be moved manually. This is especially useful where mixers are to be housed in an equipment shed.

Available for tube Ø 102 mm

Order no.: Z-Fahrwerk-004

* The agitator is not included in the scope of supply



Pivoting three point attachment

Three point attachment with hydraulic height adjustment and swivelling device*

The interaction of both hydraulic cylinders enables precise and controlled swivelling particularly in shafts that are otherwise difficult to access. If additional throttle valves are installed, the lifting speed can be adjusted, thus allowing optimum control. Height-adjustable support feet facilitate tractor hitching and unhitching.

The three point attachment is particularly suitable,

like the standard pivoting three point attachment, for pit openings greater than 600 x 700 mm and is available in a galvanised design for a external propeller cage tube diameter of Ø 102 mm.

for slurry mixers

	Order no.
- up to 4.500 mm overall length	DB-sw-4500-2Hy
- up to 4.500 mm overall length	DB-sw-5500-2Hy
- up to 4.500 mm overall length	DB-sw-6200-2Hy
Throttle valve for the hydraulic cylinder	Z-Drosselventil-01

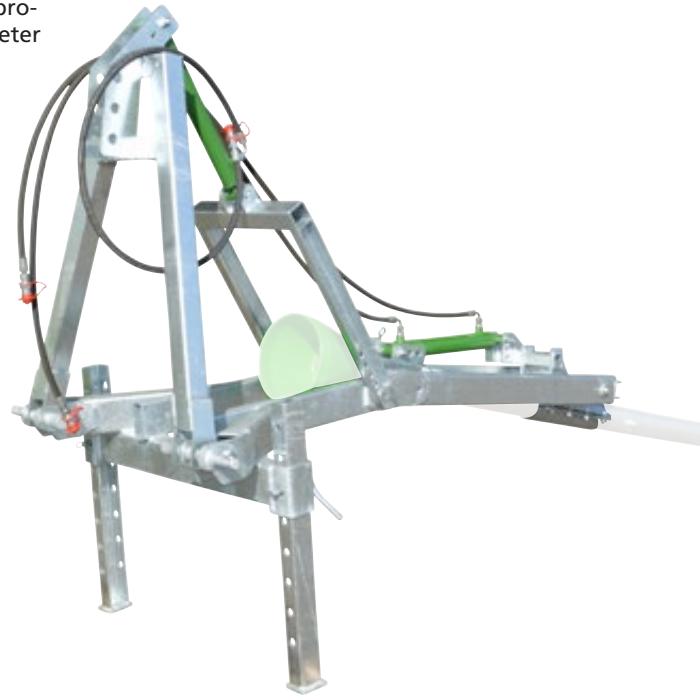

illustration

Pivoting three point attachment with lower linkage mounting, kinked*

For smaller pit openings (under 600 x 700) we have a three point attachment (also pivoting) in our range. This is of a kinked design and its height is adjusted using the lower links.

The advantage of this design is that it is easier to use in smaller pit openings. During the mixing process height adjustment is only possible via the lower links.

The specialist dealer must first be consulted before using three point attachments on the corresponding system.

Galvanised three point mounting with pivot assembly, kinked.

Can only be used with mixers that have an external tube diameter of 102 mm.

The consequence of this could be the over-flexing of the universal joint within the drivetrain. Hydraulic height adjustment cannot be used here.

For slurry mixers

	Order no.:
- Up to 4500 mm overall length	DB-sw-4500-UH
- Up to 5500 mm overall length	DB-sw-5500-UH
- Up to 6200 mm overall length	DB-sw-6200-UH

Pivoting three point attachment with lower linkage mounting

Fixed three point attachment

Fixed three point attachment with adjustment spindle*

For mixers up to 6200 mm in length. The fixed three point attachment is well suited to open slurry containers.

It is fitted as standard with the same adjustment spindle as the pivoting three point attachment.

A hydraulic height adjustment mechanism can easily be fitted.

Fixed three point attachment with adjustment spindle Galvanised. Can be used with mixers that have an external tube diameter of 102 mm.

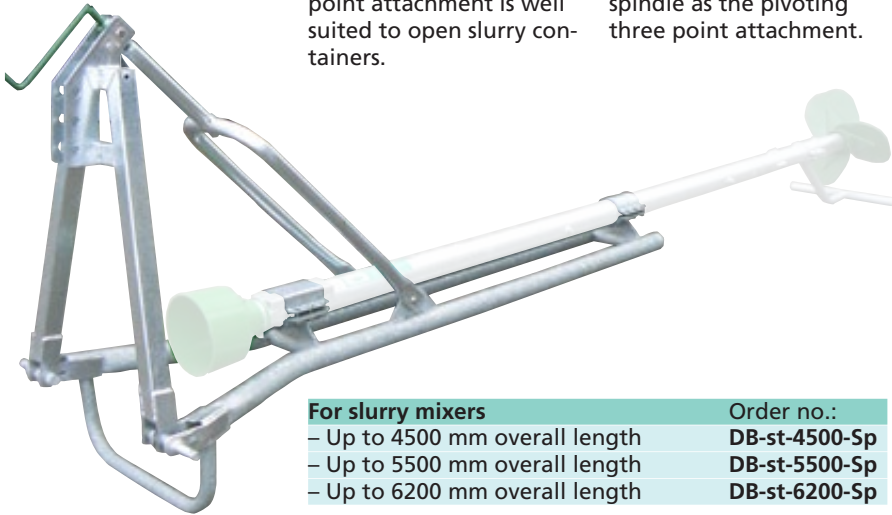

For slurry mixers	Order no.:
– Up to 4500 mm overall length	DB-st-4500-Sp
– Up to 5500 mm overall length	DB-st-5500-Sp
– Up to 6200 mm overall length	DB-st-6200-Sp

Special equipment:	Order no.:
Retrofit kit for hydraulic height adjustment	
– For mixers up to 5500 mm	DB-Hy-U-01
– For mixers up to 6200 mm	DB-Hy-U-02
Throttle valve for hydraulic cylinder	Z-Drosselventil-01

Price supplements	Order no.:
For new deliveries, in place of the adjustment spindle	
– For mixers up to 5500 mm	DB-Hy-A-01
– For mixers up to 6200 mm	DB-Hy-A-02

Fixed three point attachment with hydraulic height adjustment for mixers over 6200mm in length*

Fixed three point attachment, galvanised. For mixers over 6200 mm in length and with hydraulic height adjustment.

Can be used with stirrer outer tube Ø 102 mm.

This model is available for mixers up to 10000 mm in length and is used mainly in open slurry tanks. Hydraulic height adjustment is essential for this design because of its weight. The single-acting hydraulic cylinder is fitted with an articulating joint

to ensure that the piston rod is not subjected to axial stresses. The design prevents buckling of the piston rod. If a mixer with an open mixing propeller is used (type E2-102) we recommend fitting a reinforced propeller skid.

Standard equipment:

- Hydraulic height adjustment, stroke length 600 mm, with articulating joint in the attachment.
- Hydraulic hose, 2500 mm long, with quick coupler.



← Throttle valve (price supplement)

For slurry mixers	Order no.:
– Up to 7000 mm overall length	DB-st- 7000-Hy
– Up to 8000 mm overall length	DB-st- 8000-Hy
– Up to 9000 mm overall length	DB-st- 9000-Hy
– Up to 10000 mm overall length	DB-st-10000-Hy
Throttle valve for hydraulic cylinder	Z-Drosselventil-01



* The mixer is not included in the scope of supply

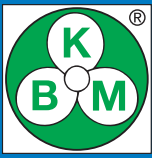

Lagoon mixer technology

We have a mixer that has been specially designed for mixing slurry lagoons - the lagoon mixer. This machine has multiple safety features to ensure that the lagoon liners

cannot be damaged. In addition, the mixer nozzle, which is angled at 30°, offers considerable advantages in comparison to a normal slurry mixer.



Type "E-102" lagoon mixer Overall lengths of 6650 mm to 10650 mm

The lagoon mixer comprises the E-102 slurry mixer fitted with a heavy duty three point attachment and an adjustable mixing nozzle.

This mixer has proven itself in use in long, deep and open slurry pits. While the lagoon mixer has been specially designed and constructed for mixing slurry lagoons, it has also proven to be highly suited for use in open earth slurry pits.

The particularly heavy duty three point mounting with hydraulic height adjustment allows an adjustable mixing nozzle to be attached. The lagoon mixer can be raised to the required height during the mixing process using the integrated hydraulic cylinder. The 30° mixing nozzle is 1000 mm long and its inclination can be adjusted by approx. 45° forwards using a separate adjusting spindle.

Using this combination, the optimum mixing of the slurry in very deep slurry pits is ensured.

Because the floor of a filled slurry pit cannot be seen, we recommend that car tyres be attached to the mixing nozzles in order to avoid damaging the pit liner. The corresponding drill holes are already in place for this.

For optimum lubrication of the upper seal we recommend the fitting of an oil expansion tank.

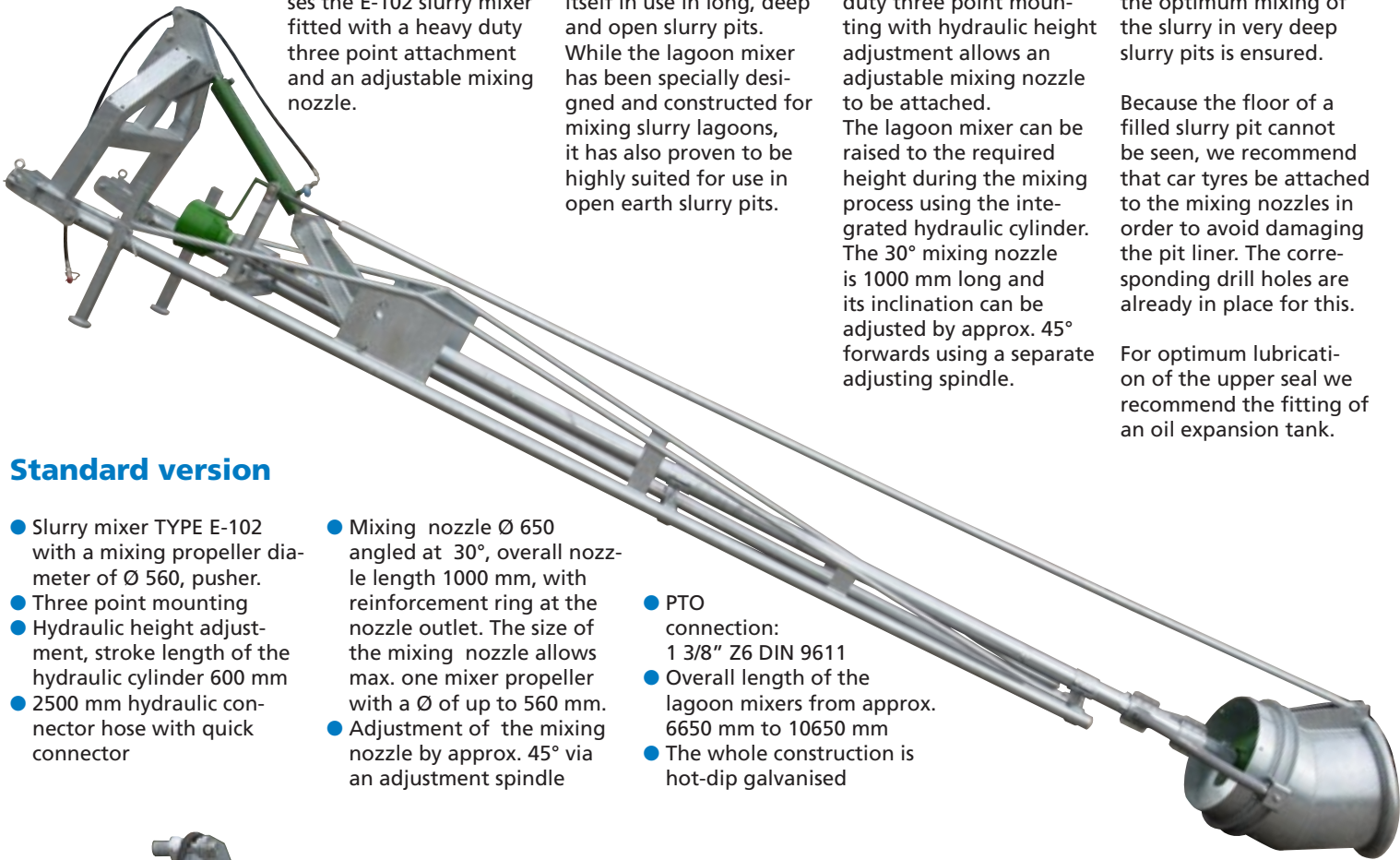

Standard version

- Slurry mixer TYPE E-102 with a mixing propeller diameter of Ø 560, pusher.
- Three point mounting
- Hydraulic height adjustment, stroke length of the hydraulic cylinder 600 mm
- 2500 mm hydraulic connector hose with quick connector
- Mixing nozzle Ø 650 angled at 30°, overall nozzle length 1000 mm, with reinforcement ring at the nozzle outlet. The size of the mixing nozzle allows max. one mixer propeller with a Ø of up to 560 mm.
- Adjustment of the mixing nozzle by approx. 45° via an adjustment spindle
- PTO connection: 1 3/8" Z6 DIN 9611
- Overall length of the lagoon mixers from approx. 6650 mm to 10650 mm
- The whole construction is hot-dip galvanised

Type "E-102" lagoon mixers

Complete lagoon mixers, maintenance-free roller bearings, maximum permissible speed 1000 rpm

	Order no.
Overall length 6650 mm	Lagune - 6650
Overall length 7650 mm	Lagune - 7650
Overall length 8650 mm	Lagune - 8650
Overall length 9650 mm	Lagune - 9650
Overall length 10650 mm	Lagune - 10650

Price supplement

Mechanical seal SiC/SiC with oil filling, price supplement on mixer	A-Preis-015
Oil filling, price supplement on mixer	A-Preis-016
Turbo agitator Ø 560 mm	A-Preis-019
Hydraulic stirring nozzles adjustment	A-Preis-023

Accessories

Throttle valve for the hydraulic cylinder	Z-Drosselventil-01
Oil expansion tank with bracket	Z-Ölbehälter-02

Lagoon mixer technology

Type "E-102" lagoon mixer – lattice construction Overall lengths from 7650 mm to 16650 mm

A development of the well-proven "Standard" lagoon mixer. It was specially designed for lengths totalling over 9650 mm and is available up to a total length of 16,650 mm.

The machine is supplied largely pre-assembled. For transportation reasons and depending upon the overall length, the mixing nozzle may be supplied separately and must be assembled on-site.

All other details are the same as for the "Standard" lagoon mixer.

Standard version

- Slurry mixer type E-102 with one mixing propeller Ø 560, pusher
- Three point mounting
- Hydraulic height adjustment, stroke length of the hydraulic cylinder 600 mm
- 2500 mm hydraulic connector hose with quick connector
- Mixing nozzle Ø 650 angled at 30°, overall nozzle length 1000 mm, with reinforcement ring at the nozzle outlet. The size of the mixing nozzle allows max. one mixer propeller with a Ø of up to 560 mm
- Adjustment of the mixing nozzle by approx. 45° via an adjustment spindle
- Overall length of the lagoon mixers from approx. 7650 mm to 16650 mm
- The whole construction is hot-dip galvanised

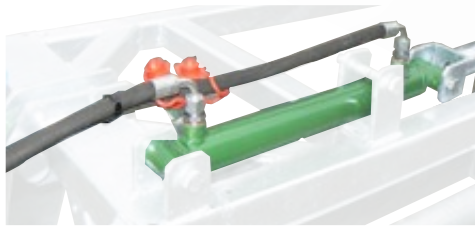
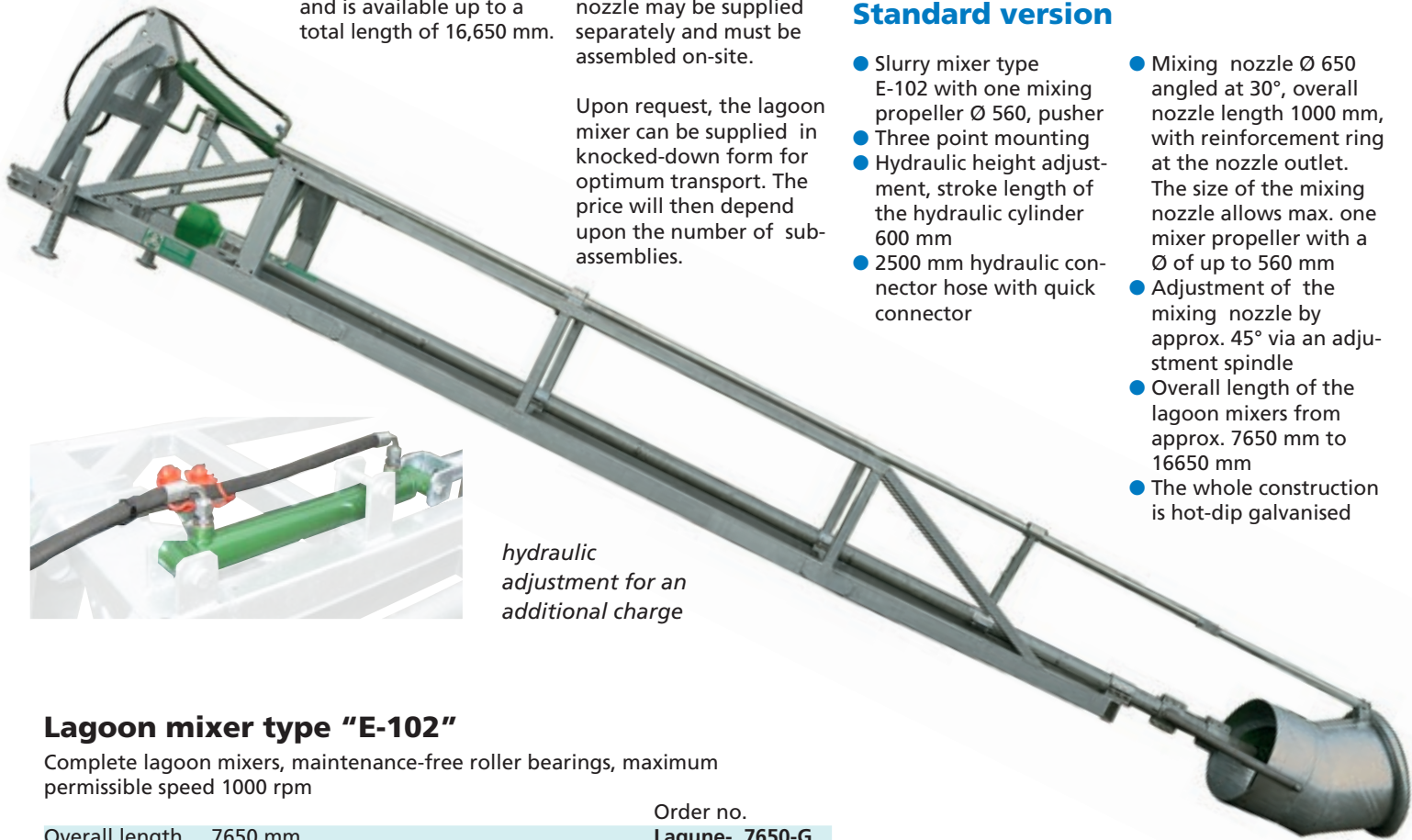

hydraulic adjustment for an additional charge

Lagoon mixer type "E-102"

Complete lagoon mixers, maintenance-free roller bearings, maximum permissible speed 1000 rpm

	Order no.
Overall length 7650 mm	Lagune- 7650-G
Overall length 8650 mm	Lagune- 8650-G
Overall length 9650 mm	Lagune- 9650-G
Overall length 10650 mm	Lagune-10650-G
Overall length 11650 mm	Lagune-11650-G
Overall length 12650 mm	Lagune-12650-G
Overall length 13650 mm	Lagune-13650-G
Overall length 14650 mm	Lagune-14650-G
Overall length 15650 mm	Lagune-15650-G
Overall length 16650 mm	Lagune-16650-G

Price supplements

Mechanical seal SiC/SiC with oil filling, price supplement on mixer	A-Preis-015
Oil filling, price supplement on mixer	A-Preis-016
Turbo agitator Ø 560 mm	A-Preis-019
Hydraulic mixing nozzle adjustment	A-Preis-023

Accessories

Throttle valve for the hydraulic cylinder	Z-Drosselventil-01
Oil expansion tank with bracket	Z-Ölbehälter-02

Throttle valve (price supplement)



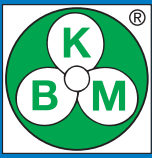

Lagoon booster

- Overall length:** Approx. 13500 mm,
Can be supplied in lengths up to 19500 mm
- Mixing propeller:** Standard Ø 850 (alternatively Ø 700,
Ø 750, Ø 800, Ø 1000 mm)
- Mixing nozzle:** Ø 1120 mm, length 1000 mm
at an angle of 30°
- Speed:** The bearings and seals are designed for
operation at up to 1000 rpm. Greatest
efficiency is achieved at up to 540 rpm
- Power requirement:** Recommendation from 250 kW (340 hp)
at 540 1 / min tractor power
- PTO shaft connection:** 1¾ inch Z6 DIN 9611



200 x 85 metre lagoon



Use in slurry lagoon 200 x 85 metres



On-site assembly



Can be knocked-down for transportation purposes

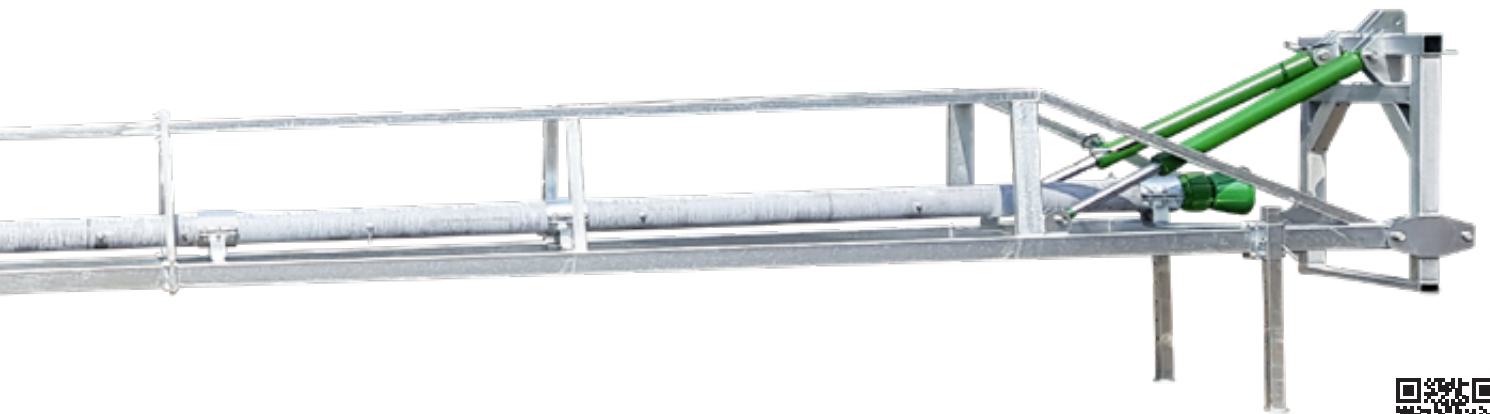

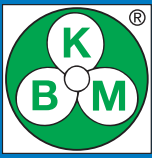

Designs for fixed installation

Lagoon mixers – Designs for fixed installation

The framework structure is ideal for slurry lagoons. Because of its stationary operation it is no longer necessary to move the machine. In order to assemble the system, both ends must be attached to a concrete plinth. The framework structure is manufactured of stainless steel and is therefore of a long-life design. Using a lever on the tractor side the nozzle and therefore the mixing stream can be adjusted by 15° in both directions.

The mixing propeller is protected by an additional tunnel of rings and steel plates. If a slurry lagoon is covered with a floating plastic sheet, then this will prevent the sheet from being sucked in and becoming damaged. The standard length of the frame construction is suitable for a 6.0 m, 9.0 m or 12.0 m long agitator. Special lengths up to 18 metres can be supplied. Mixers of the E1/HEM-102 range in the "oil filled" or "oil filled with mechanical seal", versions can be supplied for this purpose.

For occasional use the "oil filled" (sealed with shaft seals) version is sufficient. However, for longer operating times we recommend using the "oil filled with mechanical seal" version. The mixer is available either in galvanised steel or stainless steel. For optimum lubrication of the upper seal we recommend the fitting of an oil expansion tank.

Alternatively, an electric mixer can be fitted onto the framework construction. Here, we recommend our Speed range of mixers.

The scope of supply of the framework construction includes the basic frame with the nozzle, the mixing nozzle remote adjustment system and the protective rings. The whole construction is manufactured of stainless steel.

The mixer itself, in its various different versions, is a separate item.

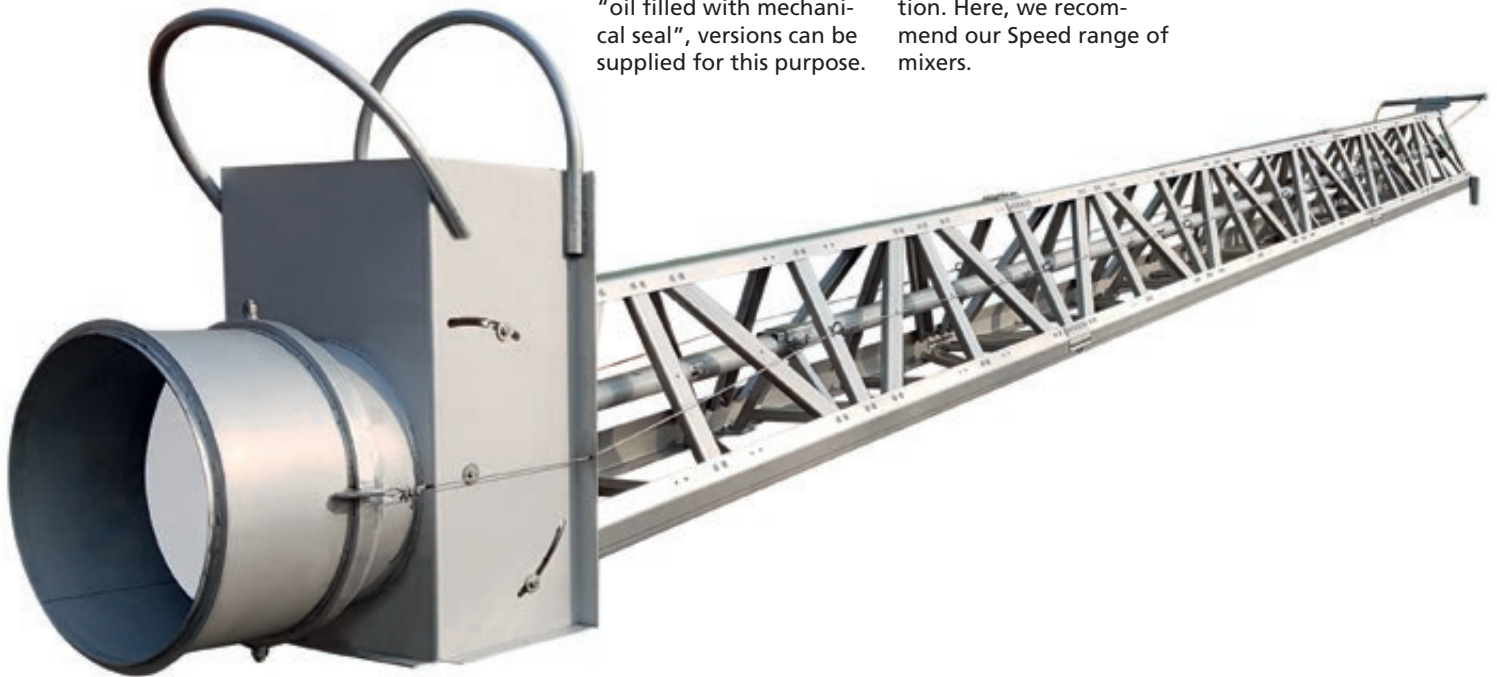

Lagoon mixers for fixed installation			Order no.
Length 6000 mm	Mixing nozzle with protective cage and framework construction	6000	Lagune- 6000-F
Length 9000 mm	Mixing nozzle with protective cage and framework construction	9000	Lagune- 9000-F
Length 12000 mm	Mixing nozzle with protective cage and framework construction	12000	Lagune-12000-F

Mixer technology		
PTO mixer	E1/HEM-102 x 6000, E1/HEM-102 x 9000 and E1/HEM-102 x 12000	Pages 4+5
Electric mixer	Speed x 6000, Speed x 9000 and Speed x 12000	Page 8

Three point attachment extension

Slurry mixer frame extension Longhorn type



Application:
For open elevated slurry tanks with an external height of 3.75 m above the tractor working area.

Without a frame extension a slurry tank can be mixed at a height of approx. 0.35 m above the tractor working area.

Depending upon the size of the tractor, a mixer tower is necessary for mixing containers with a lip height of approx. 0.50 m. An alternative solution here is the slurry mixer frame extension. When using the frame extension, each Buschmann slurry mixer with a three-point hitch (except the lagoon booster and F-168)

can be extended to a maximum length of 16 m for use in open pits.

For third-party products only after technical clarification.

We recommend the use of a mixer with a pusher propeller. If a mixer with an open mixing propeller is used (type E2-102) we recommend fitting a reinforced propeller skid.

Advantages of the slurry mixer frame extension:

- Existing KBM slurry mixers with a three-point linkage can be used
- More flexible range of applications
- Various container heights can easily be accommodated
- Lower acquisition costs than for a mixer tower

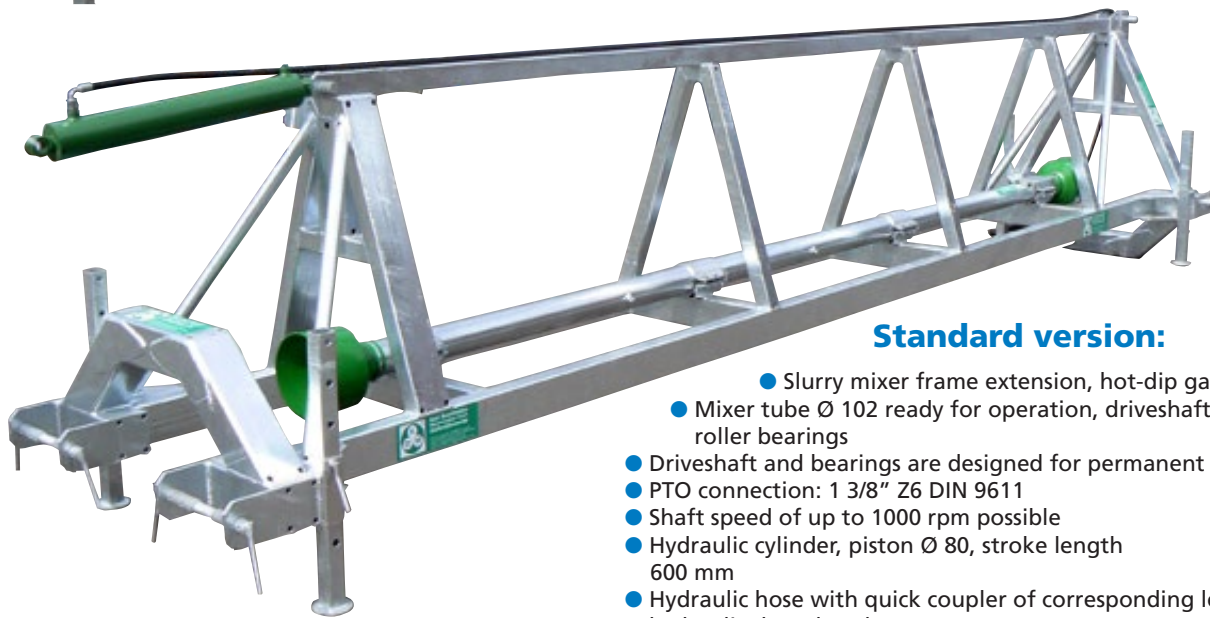

Standard version:

- Slurry mixer frame extension, hot-dip galvanised version
- Mixer tube Ø 102 ready for operation, driveshaft runs on maintenance-free roller bearings
- Driveshaft and bearings are designed for permanent operation.
- PTO connection: 1 3/8" Z6 DIN 9611
- Shaft speed of up to 1000 rpm possible
- Hydraulic cylinder, piston Ø 80, stroke length 600 mm
- Hydraulic hose with quick coupler of corresponding length
- hydraulic throttle valve

The basic equipment you will need will be a slurry mixer frame extension, two drive shafts and a hydraulic cylinder with connector hose or a tractor with hydraulically adjustable upper links. The hydraulic upper links are necessary to lift the frame over the obstacle. Without this, it can be used as a pure extension. A wide-angle drive shaft on both sides between the frame extension and the mixer is essential. The necessary drive shafts can be supplied as accessory items.

Tank height	Description	Length	Order no.
1500 mm	Frame extension	2500 mm	DB-RV-2500
1750 mm	Frame extension	3000 mm	DB-RV-3000
2000 mm	Frame extension	3500 mm	DB-RV-3500
2250 mm	Frame extension	4000 mm	DB-RV-4000
2500 mm	Frame extension	4500 mm	DB-RV-4500
2750 mm	Frame extension	5000 mm	DB-RV-5000
3000 mm	Frame extension	5500 mm	DB-RV-5500
3250 mm	Frame extension	6000 mm	DB-RV-6000
3500 mm	Frame extension	6500 mm	DB-RV-6500
3750 mm	Frame extension	7000 mm	DB-RV-7000

The tank heights that can be reached may vary according to the type of tractor used.

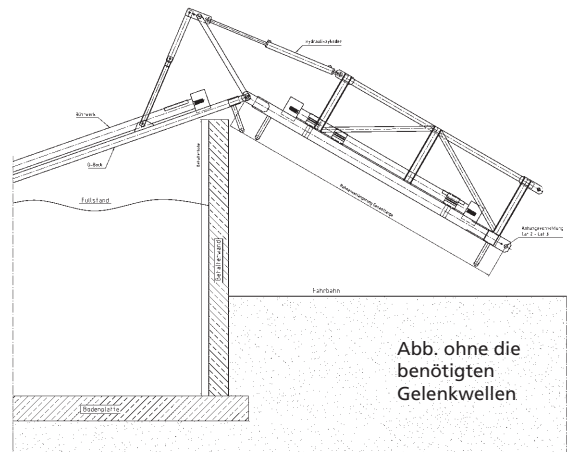

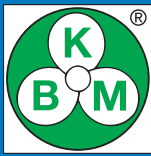

Open systems Type 2

Type 2 PTO mixers

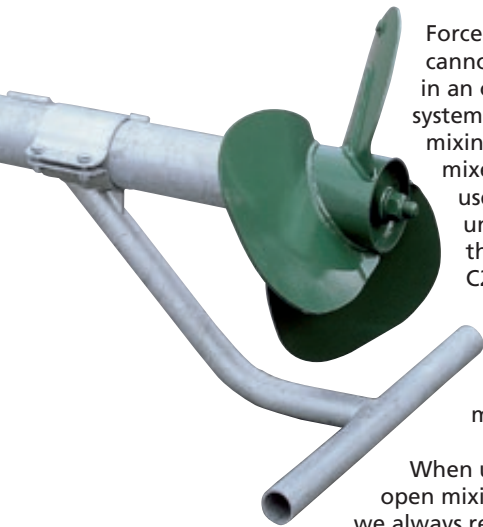

Forced circulation cannot be achieved in an open mixing system. For open mixing, type "2" mixers should be used. Standard units here are the type B2-60, C2-76, C2-102, C/E2-76, C/E2-102, E2-76, E2-102 mixers.

When using an open mixing propeller we always recommend the use of a mixer with a pusher propeller. The resulting currents can be advantageous.

As standard, all mixers are fitted with a suction propeller because not all mixer types are suitable for pusher propellers.

The mixers are fitted as standard with a propeller skid. The normal propeller skid is only intended to protect the mixing propeller. The normal propeller skid is not suitable for the circulation system because it has not been designed to withstand the axial forces that arise. In order to ensure the system can be used in the smallest of pit openings the propeller skid has been kept very short.

The transverse tube provides additional protection for the mixer against knocks from the side.

With special glide rail designs, type "2" mixers can also be used. The requirement for this is that the glide rail is fitted with locking elements on both sides. In order to fulfil all of the requirements we offer a reinforced propeller skid with 2 brackets and reinforced, support tube that is capable of withstanding the axial loads.

Because the open mixing propellers in circulation systems exhibit a performance loss of approx. 30% compared with mixers with

a fixed propeller cage, we do not recommend this type of mixing for circulation systems.

The type "2" slurry mixers (open mixing propellers) may only be used with a three point attachment. When fitted with a reinforced propeller skid and used in a circulation system, a bracket integrated into the angled rail can prevent the mixer from overturning.

For oil-filled mixers we recommend the fitting of an oil expansion tank to ensure optimum lubrication of the upper seal.

Complete slurry mixers, without three point attachment

Mixer type	External tube Ø mm	Standard mixer shaft lengths									
		3.700 mm Order no.	4.200 mm Order no.	4.600 mm Order no.	5.200 mm Order no.	6.000 mm Order no.	7.000 mm Order no.	8.000 mm Order no.	9.000 mm Order no.		
B2-60	60	B2- 60-3700	B2- 60-4200	B2- 60-4600	B2- 60-5200						
C2-76	76	C2- 76-3700	C2- 76-4200	C2- 76-4600	C2- 76-5200	C2- 76-6000					
C2-102	102	C2- 102-3700	C2- 102-4200	C2- 102-4600	C2- 102-5200	C2- 102-6000					
C/E2-76	76	C/E2- 76-3700	C/E2- 76-4200	C/E2- 76-4600	C/E2- 76-5200	C/E2- 76-6000					
C/E2-102	102	C/E2- 102-3700	C/E2- 102-4200	C/E2- 102-4600	C/E2- 102-5200	C/E2- 102-6000					
E2-102	102	E2- 102-3700	E2- 102-4200	E2- 102-4600	E2- 102-5200	E2- 102-6000	E2- 102-7000	E2- 102-8000	E2- 102-9000		
E2-102	102	E2- 102-10000	E2- 102-11000	E2- 102-12000	Further lengths upon request						

Rührwerktyp	Propeller skid	Mixer propeller	Shaft bearing	Drehzahlbegrenzung
B2-60	inclusive	Ø 380-suction	Roller + glide bearings	540 1/min
C2-76	inclusive	Ø 560-suction	Roller + glide bearings	540 1/min
C2-102	inclusive	Ø 560-suction	Roller + glide bearings	540 1/min
C/E2-76	inclusive	Ø 560-pusher	Roller + glide bearings	540 1/min
C/E2-102	inclusive	Ø 560-pusher	Roller + glide bearings	540 1/min
E2-102	inclusive	Ø 560-pusher	Maintenance-free roller	1.000 1/min

Price supplements		Order no.
Increasing the standard mixing propeller diameter from Ø 560 mm to up to Ø 700 mm		A-Preis-001
Reinforced propeller skid		A-Preis-003
Mechanical seal SiC/SiC	With oil filling, price supplement on mixer E-102	A-Preis-015
Oil filling	Price supplement on mixer E-102	A-Preis-016
Turbo mixing propeller Ø 560 mm in place of standard mixing propeller Ø 560 mm, Available with stirrer Ø 102		A-Preis-019
Turbo mixing propeller Ø 600 mm in place of standard mixing propeller Ø 560 mm, Available with stirrer Ø 102		A-Preis-020
Gearbox flange (only Typ C/E2-102 or E2-102)		Z-Flansch-001
Accessories		Order no.
Hanging clamp	For transport with a front loader, transport bracket	Z-Schelle-001
Lower linkage mounting	Available for all PTO mixers	Z-Halterung-003
Reversing gearbox	Can only be used with type C/E2-102 or E2-102, fitted on delivery of a new complete system or available separately as a retrofit kit	Z-Getriebe-001
Pivoting three point attachment	With adjustment spindle, for mixer lengths up to	DB-sw-4500-Sp DB-sw-5500-Sp DB-sw-6200-Sp
Fixed three point attachment	With adjustment spindle, for mixer lengths up to	DB-st-4500-Sp DB-st-5500-Sp DB-st-6200-Sp
Oil expansion tank	With 1/2" thread	Z-Ölbehälter-01
Sacrificial anode	With galvanised bracket	Z-Opferanode-01
Sacrificial anode	With Stainless steel bracket	Z-Opferanode-02

Propeller skids



Propeller skid, standard version

Suitable for mixer types:
B2-60, C2-76, C2-102, C/E2-76, C/E2-102, E2-102, L-E2.
With half clamp and 4 mounting bolts

Order no. **Kufe-001**



Propeller skid, reinforced version

Suitable for mixer types: C2-102, C/E2-102, E2-102.
Application: In forced circulation systems with glide
rails. Item is specially manufactured. With two half
clamps and mounting bolts

Order no. **Kufe-002**



Propeller skid with Ø 590 tyre bracket and joint

Reinforced version.
Suitable for mixer types C2-102, C/E2-102, E2-102.
With two half clamps and mounting bolts

Order no. **Kufe-003**

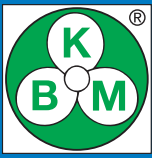

Front loader bracket Diggermix

Fast change bracket

All slurry mixers with an outside tube diameter Ø 102 can be fitted to this fast change bracket.

Mixers with electric motor or with integrated hydraulic motors are suitable for mixing. We recommend the use of a mixer with a pusher propeller.

If a mixer with an open mixing propeller is used (type E2-102) we recommend fitting a reinforced propeller skid.

Unless otherwise specified, the connection plates are supplied for a Euro mount.

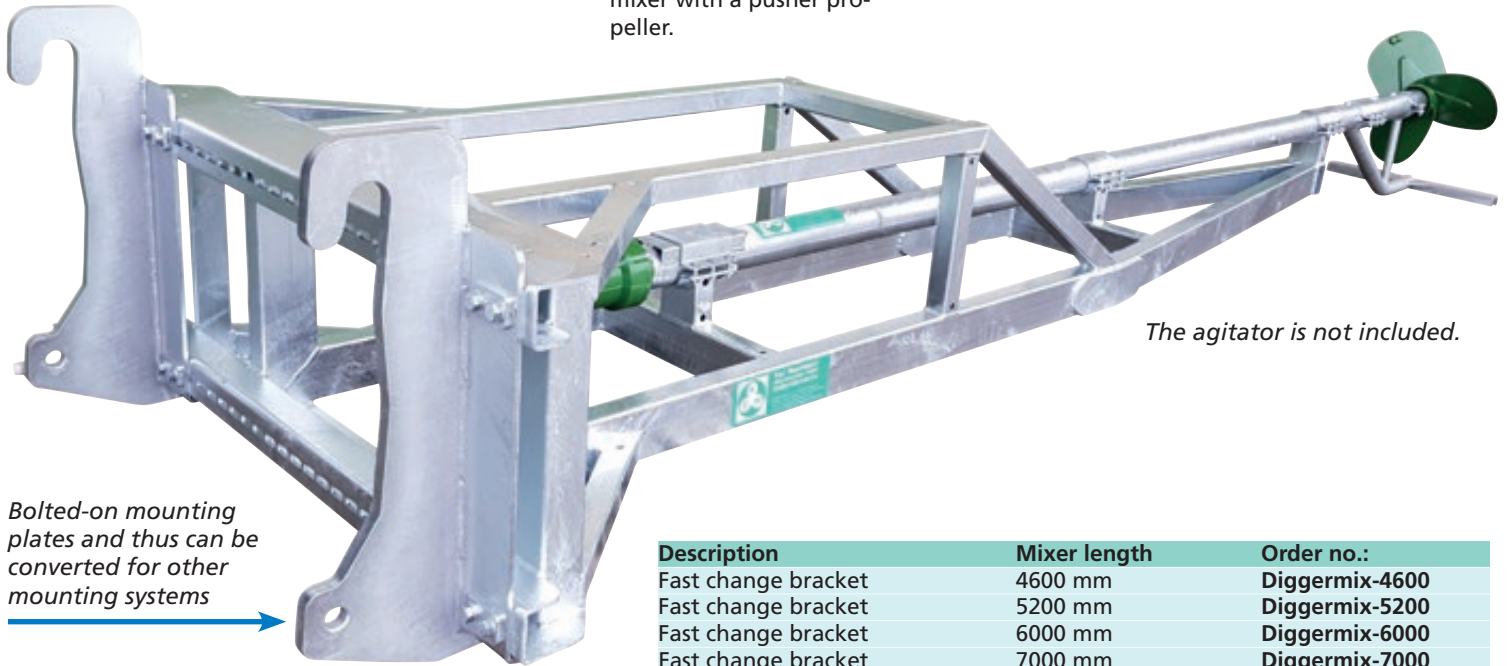

The agitator is not included.

Bolted-on mounting plates and thus can be converted for other mounting systems

Description	Mixer length	Order no.:
Fast change bracket	4600 mm	Diggermix-4600
Fast change bracket	5200 mm	Diggermix-5200
Fast change bracket	6000 mm	Diggermix-6000
Fast change bracket	7000 mm	Diggermix-7000
Fast change bracket	8000 mm	Diggermix-8000
Fast change bracket	9000 mm	Diggermix-9000



Special attachments upon request



Hydraulic motor for slurry agitator

Driving mixers through an integrated hydraulic motor offers the following benefits:

- Retrofit installation is possible on all mixers of the C/E-102 and E-102 ranges
- Two directions of rotation enable suction and pressure operation of the propeller..

- In this manner it is therefore possible to mix elevated slurry tanks, open slurry pits, closed deep pits and circulation systems using one and the same mixer.
- It is possible to fit the system to a front loader, wheel loader and telescopic loader using the corresponding bracket.

Scope of supply:
Orbital motor with bracket, shaft coupling and welding flange. Hydraulic motor with gear stage and welded flange. The hydraulic hoses with connection fittings are not included in the price.

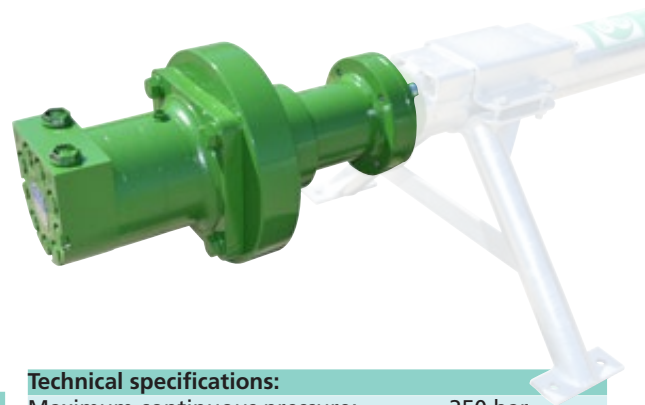

Order no.:
Z-Hydraulikmotor-01

Technical specifications:

Maximum continuous pressure:	250 bar
Maximum oil flow:	140 l/min.
Feed connection:	3/4 Zoll
Return connection:	3/4 Zoll
Pressureless leakage oil pipe connection:	3/4 Zoll
Max. number of revolutions:	380 1/min.
Max. power	35 KW

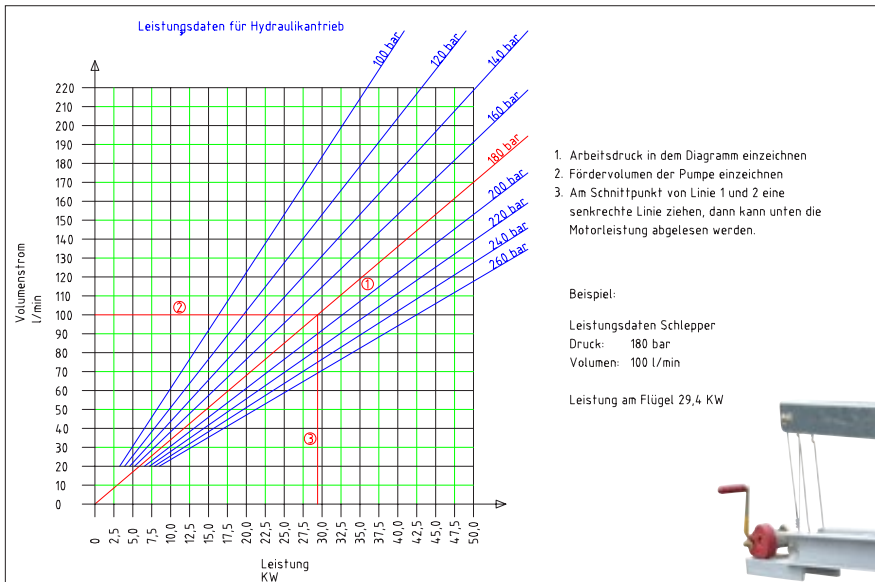

Elevated slurry tank mixer mounting for fixed operation

This device allows the mixer to be used on a front loader to mix slurry tanks up to 4.5 m in height – even where several elevated slurry tanks are in use. In this mounting the mixer can be pivoted between 0° – 180° and tilted

through 60°. Tilt adjustment is achieved via a cable winch.

Version in galvanized, suitable for stirrer tube Ø 102 mm

Order no.:
Z-Halterung-006



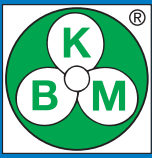

Electric mixer cart

Type S-E2 electric mixer



The type S-E2 electric slurry mixer is a fast-running mixer with a motor that is directly connected with a flange.

Design:
Mixer tube Ø 76 mm, propeller skid and motor grip are hot-dip galvanised.

The motor is fitted with a Star-Delta reversing switch for selecting forward and reverse operation, integrated motor protection circuit breaker with undervoltage trip in the switch box and a CEE device plug. The drive shaft runs on maintenance-free roller bearings. Sealing is achieved with rotary shaft lips type seals on bushes that are fitted with stainless

steel tension springs in place of a normal one.

The unit works without an oil filling and requires very low maintenance.

If the mixer is used for fixed operation we recommend the oil-filled version, and if long operating times are envisaged, mechanical seals should be selected.

The 3250, 3750 and 4250 mm lengths are preferred with a motor rating of 5.5 or 7.5 kW.

While all other lengths are listed and can be supplied, these are considered custom-made products. Custom-made products cannot be exchanged!

Electric slurry mixer Type S-E2 (1450 rpm)

With CEE device plug, star-delta reversing switch, motor protection circuit breaker and undervoltage trip

Motor rating kW	Mixing propeller	Mixer tube length					
		1.250 mm Order no.	1.750 mm Order no.	2.250 mm Order no.	2.750 mm Order no.	3.250 mm Order no.	3.750 mm Order no.
4,0	Ø 220-Push	S-E2-040-1250	S-E2-040-1750	S-E2-040-2250	S-E2-040-2750	S-E2-040-3250	S-E2-040-3750
5,5	Ø 250-Push	S-E2-055-1250	S-E2-055-1750	S-E2-055-2250	S-E2-055-2750	S-E2-055-3250	S-E2-055-3750
7,5	Ø 280-Push	S-E2-075-1250	S-E2-075-1750	S-E2-075-2250	S-E2-075-2750	S-E2-075-3250	S-E2-075-3750
11,0	Ø 320-Push	S-E2-110-1250	S-E2-110-1750	S-E2-110-2250	S-E2-110-2750	S-E2-110-3250	S-E2-110-3750
15,0	Ø 350-Push	S-E2-150-1250	S-E2-150-1750	S-E2-150-2250	S-E2-150-2750	S-E2-150-3250	S-E2-150-3750

Motor rating kW	Mixing propeller	Mixer tube length				
		4.250 mm Order no.	4.750 mm Order no.	5.250 mm Order no.	5.750 mm Order no.	6.000 mm Order no.
4,0	Ø 220-Push	S-E2-040-4250	S-E2-040-4750	S-E2-040-5250	S-E2-040-5750	S-E2-040-6000
5,5	Ø 250-Push	S-E2-055-4250	S-E2-055-4750	S-E2-055-5250	S-E2-055-5750	S-E2-055-6000
7,5	Ø 280-Push	S-E2-075-4250	S-E2-075-4750	S-E2-075-5250	S-E2-075-5750	S-E2-075-6000
11,0	Ø 320-Push	S-E2-110-4250	S-E2-110-4750	S-E2-110-5250	S-E2-110-5750	S-E2-110-6000
15,0	Ø 350-Push	S-E2-150-4250	S-E2-150-4750	S-E2-150-5250	S-E2-150-5750	S-E2-150-6000

Price supplement		Order no.
Mechanical seal SiC/SiC	With oil filling, price supplement on the mixer	A-Preis-015
Oil filling Type S-E2	Price supplement on the mixer	A-Preis-017
Protective ring Type S-E2	In place of the standard skid type S-E2	A-Preis-018

Accessories		Order no.
Transport cart	For S-E2 mixers with motor up to 7.5 kW	Z-Fahrwerk-003
Elevated slurry tank mixer bracket	For stationary operation	Z-Halterung-006
Front loader bracket	With transverse pivoting system	Z-Halterung-005

Cart for type S-E2 electric mixer

Tubular frame construction of sturdy design, hot-dip galvanised, mixer bracket with painted joint and attachment bracket and wheels with pneumatic tyres that run on roller bearings.

Specification:	
Overall width	600 mm
Wheels:	Ø 400 x 100, pneumatic tyres, roller bearings
Tilt angle:	Adjustment range 0°– 90°
Lateral adjustment:	Pivots through 0°–360°



Accessories for type S-E2



Protective ring S-E2

Suitable for mixer type S-E2
The protective ring provides all-round protection for the mixing propeller.

Price supplement protective ring instead of skid	A-Preis-018
Protective ring with bolts	Z-Schutzring S-E2

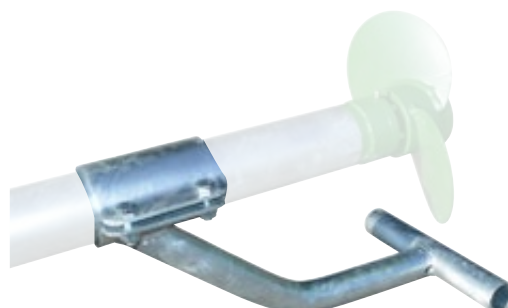

Type S-E2 propeller skid

Standard skid suitable for mixer type S-E2

Order no.: Kufe-004



S-E2 bracket, fixed

Bracket for the fixed mounting of type S-E2 mixers. In contrast to the normal Type S-E2 bracket, the mixer can be pivoted laterally and its tilt angle adjusted.

This bracket is optimally suited for stationary operation.

Order no.: Z-Halterung S-E2 stationär



Type S-E2 bracket

Bracket for the fixed mounting of Type S-E2 mixers

Order no.: Z-Halterung S-E2

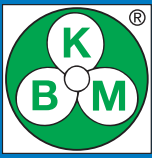

Slatted-floor agitators

Slatted-floor agitators often provide a good solution in otherwise hopeless situations, for

mixing non-flowing slurry channels. They can be used with all mixers by lowering a mixing paddle

through the gaps in the slatted floor of the cattle shed.



Mobile slatted-floor agitators mixer with quick change device for a wide range of locations

Minimum dimensions of the slatted floor gaps:

Slatted floor for pigs:
17 x 150 mm (5.5 kW)
17 x 170 mm (7.5 kW)

Slatted floor for cows:
23 x 190 mm (7.5–9.2 kW)

Drive motor:
Rating 5.5 kW–7.5 kW
or 9.2 kW

With Star-Delta reversing switch, integrated motor protection circuit breaker with undervoltage trip and a CEE device plug.

Quick change device:
The quick change device allows the mixing blade to be removed and replaced with another in seconds.

1st advantage:
The changeover from an slatted-floor agitators for pigs to an slatted-floor agitators for cows is carried out by changing the mixing blade.

2nd advantage:
The immersion depth can be changed by fitting a longer knife, because removing the mixing blade is a fast and easy operation.

3rd advantage:
The motor is lowered for transport. This achieves a lower centre of gravity. Because the motor can only be pivoted laterally to a maximum of 38° it is not possible for slurry or condensate to enter into the motor.

4th advantage:
The mixing blade can be attached offset by 90° allowing it to be used longitudinally in relation to the floor. This means that mixing can be carried out even in very confined areas.

Mixer shaft bearings:
The drive shaft runs on maintenance-free radial and axial ball bearings in the area of the clutch. This protects the electric motor mounting. In the areas that come into contact with slurry the drive shaft runs on slide bearings made of a special bronze alloy. In order to increase the service life of the special slide bearings, one half of the mixing knife is packed with grease. When the bearing points heat up the slide bearings are therefore automatically lubricated.

Addition of water:
A through bore in the bearing also allows water to be introduced to mix with the slurry. The volume of water flowing

through the bearing can be varied using an adjusting wedge.

For more comfortable handling, we recommend the castor set from the range of accessories. This can be retrofitted at any time.

Standard equipment:

- VA stainless steel knife with shaft and fixed VA stainless steel blades, for sucking or pushing
- Water feed to mixing propeller and bearings
- Automatic grease lubrication system
- Pneumatic tyres
- The mixing blade is raised or lowered to the height required for different pit depths using a cable winch
- Double pivot system. The lateral pivot system which allows angles of approx. 38° to the left and right expands the radius of action.
- Elastic BIPEX clutch. The connection between the motor and the mixer shaft is made with a replaceable polyurethane cam ring.
- Possible to offset the mixing knife transversely by 90°.



Special accessories:
set of swivel casters
with locking brake

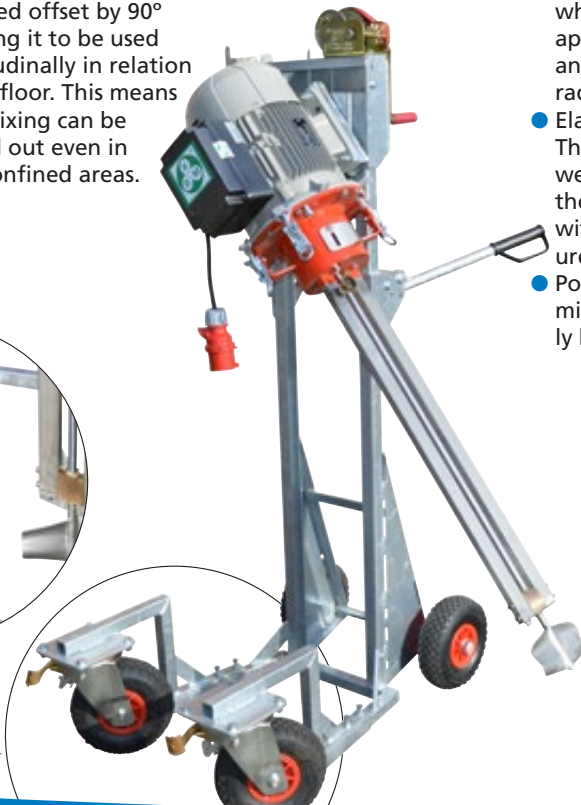

Slatted-floor agitators

Mobile slatted-floor agitators with quick change device

Item description	Knife length	Motor rating	Machine height	Machine width	Order no.:
slatted-floor agitators for pig slurry	700 mm	5,5 kW	1.510 mm	600 mm	SPS-55-070
	700 mm	7,5 kW	1.510 mm	600 mm	SPS-75-070
	1.000 mm	5,5 kW	1.740 mm	600 mm	SPS-55-100
	1.000 mm	7,5 kW	1.740 mm	600 mm	SPS-75-100
	1.300 mm	5,5 kW	2.020 mm	600 mm	SPS-55-130
	1.300 mm	7,5 kW	2.020 mm	600 mm	SPS-75-130
	1.500 mm	5,5 kW	2.320 mm	600 mm	SPS-55-150
	1.500 mm	7,5 kW	2.320 mm	600 mm	SPS-75-150
slatted-floor agitators for cow slurry	700 mm	5,5 kW	1.510 mm	600 mm	SPR-55-070
	700 mm	7,5 kW	1.510 mm	600 mm	SPR-75-070
	700 mm	9,2 kW	1.510 mm	600 mm	SPR-92-070
	1.000 mm	5,5 kW	1.740 mm	600 mm	SPR-55-100
	1.000 mm	7,5 kW	1.740 mm	600 mm	SPR-75-100
	1.000 mm	9,2 kW	1.740 mm	600 mm	SPR-92-100
	1.300 mm	5,5 kW	2.020 mm	600 mm	SPR-55-130
	1.300 mm	7,5 kW	2.020 mm	600 mm	SPR-75-130
	1.300 mm	9,2 kW	2.020 mm	600 mm	SPR-92-130
	1.500 mm	5,5 kW	2.320 mm	600 mm	SPR-55-150
	1.500 mm	7,5 kW	2.320 mm	600 mm	SPR-75-150
	1.500 mm	9,2 kW	2.320 mm	600 mm	SPR-92-150

Special accessories

Handbrake		Z-SPS-003
Set of swivelling castors with parking brake		Z-SPS-004
Cost for on-site trial (not payable if machine is purchased)		Z-SPS-005
Blade cover	700 mm	Z-SPS-007
Blade cover	1000 mm	Z-SPS-008
Blade cover	1300 mm	Z-SPS-009
Blade cover	1500 mm	Z-SPS-010
Tubeless tyres, 2 PU wheels, expanded, price supplement		Z-SPS-011
Depth stop, For the carriage plate Lowering stop to 60 mm		Z-SPS-012

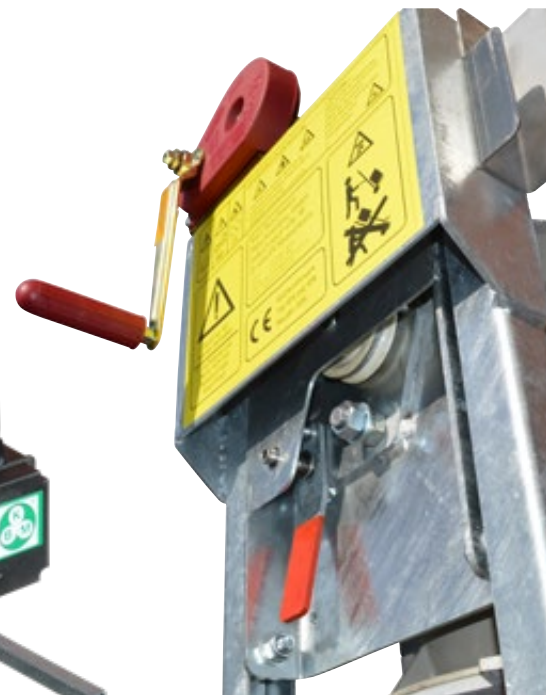



Slatted-Floor agitators

This range of slow-running mixers operates at a speed of 80 rpm. A minimum slot gap of 35 mm is required because of the size of the mixing paddle. The motor coupling

with the DIN profile of the power take-off shaft allows the mixing paddle to be changed quickly. The Z-shaped mixing paddle makes either a suction or pushing flow

direction possible. The advantage of this range of mixers is that no bearings, rotating or wearing parts come into contact with the slurry which ensures low maintenance

requirements. The compact design with pull-out grips guarantees easy transport.



Slatted-floor slurry agitators SP 1 – 3/80

Hot-dip galvanised tubular frame, 2 wheels on roller bearings (400 x 100, pneumatic tyres) for transportation. Ø 35 mm drive shaft with 1 3/8" slot-in PTO shaft coupler in accordance with DIN 9611.

Height adjustment by safety cable winch. Drive via 3 kW/80 rpm geared motor. Attached motor protection switch with undervoltage release. Bracket for fixing to the slatted floor. Connector cable with Euro plug.

Dimensions:
 Overall width 600 mm
 Overall height 1900 mm
 Overall length 1100 mm
 Immersion depth 1150 mm
 Paddle wide 775 mm
 Paddle height 150 mm

Slatted-floor agitators Type SP 1 - 3/80 (3.0 kW motor at 80 rpm.)	Order no. SP-1-3/80
---	------------------------



Slatted-floor slurry agitators SP 3 – 3/80

Hot-dip galvanised tubular frame, 2 wheels on roller bearings (400 x 100, pneumatic tyres) for transportation. Ø 35 mm drive shaft with 1 3/8" slot-in PTO shaft coupler in accordance with DIN 9611.

Lower intermediate mounting. This is required because of the immersion depth. Height adjustment by safety cable winch. Drive via 3 kW/80 rpm geared motor.

Attached motor protection switch with undervoltage release. Bracket for fixing to the slatted floor. Connector cable with Euro plug.

Dimensions:
 Overall width 1200 mm
 Overall height 2420 mm
 Overall length 1060 mm
 Immersion depth 1500 mm
 Paddle wide 775 mm
 Paddle height 150 mm

Slatted-floor agitators type SP 3 - 3/80 (3.0 kW motor at 80 rpm.)	Order no. SP-3-3/80
---	------------------------

Special accessories:	Order no.
Mixing paddle, movable, with hinge.	Z-SP-001
Mixing paddle Ø 35 mm, with PTO shaft coupler to DIN 9611, 1800 long or intermediate lengths manufactured to specification.	Z-SP-002

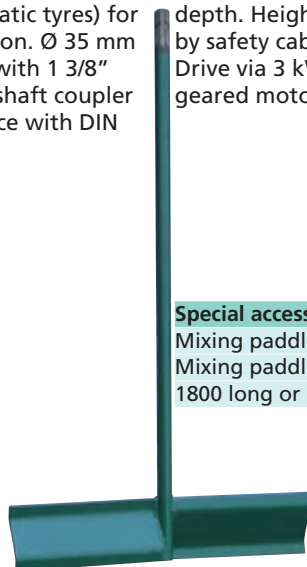

Slatted-Floor agitators

Type K Slatted-floor agitators (for cow slurry)

The type K model is one of the faster running slatted-floor agitators at 1450 rpm.

In contrast to the SP1 & SP3 range, the type K slatted-floor agitators can be used with a gap width of

30 x 220 mm. By using a special switching unit the mixer can easily be used anywhere where there is a 3-phase, 220 Volt, 50 Hz power supply (please state when ordering)



Using an adjustment lever it is possible to direct the mixer stream in various directions.

The Ø 330 mm drive shaft and folding propeller blades are manufactured of stainless steel.

The design of the folding mechanism means that only pusher operation is possible.



Available versions:

Motor	Knife length	Machine width	Order no.
5.5 kW	650 mm	550 mm	K-065
5.5 kW	800 mm	550 mm	K-080
5.5 kW	950 mm	550 mm	K-095
5.5 kW	1250 mm	550 mm	K-125
5.5 kW	1500 mm	550 mm	K-150

Type S Slatted-floor agitators (for pig slurry)

The type S model is one of the faster running slatted-floor agitators at 1450 rpm.

In contrast to the SP1 & SP3 range, the type S slatted-floor agitators can be used with a gap width of 16 x 300 mm.

By using a special switching unit the mixer can easily be used anywhere where there is a 3-phase, 220 Volt, 50 Hz power supply (please state when ordering).

Using a cable winch the mixing blade can be set at various depths.

The drive shaft and folding propeller blades are manufactured of stainless steel.

The design of the folding mechanism means that only pusher operation is possible.



Available versions:

Motor	Knife length	Machine width	Order no.
4.0 kW	650 mm	550 mm	S-065
4.0 kW	950 mm	550 mm	S-095

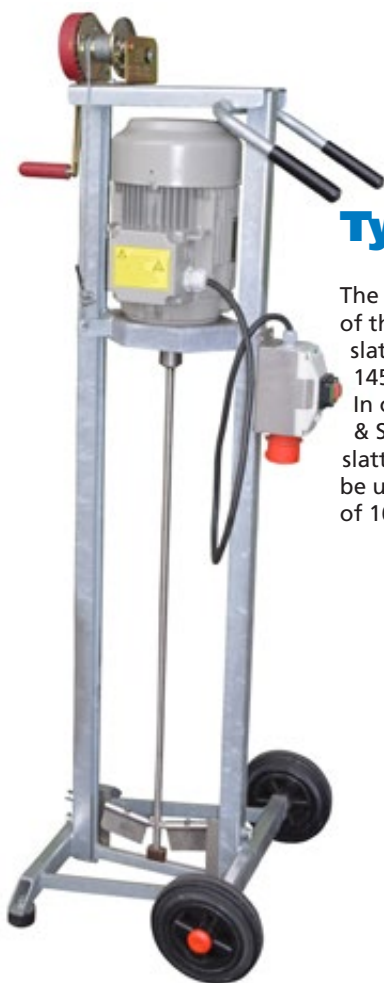

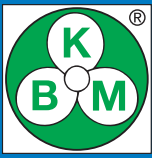

F1-168 and F2-168 slurry mixers

F-168

The type F-168 tractor mixer sets new standards in mixing technology. A particularly heavy-duty version provides for more stability and a higher mixing performance. To operate this model, we recommend tractor power of 250 kW (340 hp) and more at 540 rpm.

Technical Details:

- Massive mixing propeller Ø 850 mm (alternatively Ø 700, Ø 750, Ø 800), either as a suction or as a pusher
- Reinforced mixing pipe Ø 168.3 mm
- Multi-ball bearing module shafts Ø 45 mm in oil bath
- PTO connection 1 ¾ inch Z6 DIN 9611
- Low-wear SiC/SiC mechanical seal for a long service life

- Series "1" with mixer basket 1,000 x 1,000 mm (alternatively cage 800 x 800) or series "2" with reinforced skid
- Two directions of rotation permitted

A rigid three-point hitch is available on request. To lubricate the front bearing, the installation of an oil expansion tank is absolutely necessary. This can be supplied by the customer or ordered

at the same time as an accessory. The required size of the tank depends on the length of the mixer, and it should have a volume of at least 6 litres.

If the F-168 mixer is ordered in stainless steel, all components that come into contact with the medium are made of stainless steel.

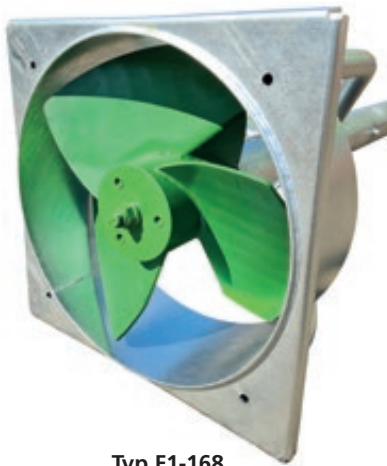

Typ F1-168

Complete agitator tube F-168 ready for operation, with protective funnel, agitator blade Ø 850 suction and agitator cage 1000 x 1000 mm

Shaft length	Galvanised	Stainless steel
3.200 mm	F1-168- 3200-vs	F1-168- 3200-VA
3.700 mm	F1-168- 3700-vs	F1-168- 3700-VA
4.200 mm	F1-168- 4200-vs	F1-168- 4200-VA
4.600 mm	F1-168- 4600-vs	F1-168- 4600-VA
5.200 mm	F1-168- 5200-vs	F1-168- 5200-VA
6.000 mm	F1-168- 6000-vs	F1-168- 6000-VA
7.000 mm	F1-168- 7000-vs	F1-168- 7000-VA
8.000 mm	F1-168- 8000-vs	F1-168- 8000-VA
9.000 mm	F1-168- 9000-vs	F1-168- 9000-VA
10.000 mm	F1-168-10000-vs	F1-168-10000-VA
11.000 mm	F1-168-11000-vs	F1-168-11000-VA
12.000 mm	F1-168-12000-vs	F1-168-12000-VA



Typ F2-168

Complete agitator tube F-168 ready for operation, with protective funnel, agitator blade Ø 850 pressure and reinforced skid width 1000 mm

Shaft length	Galvanised	Stainless steel
3.200 mm	F2-168- 3200-vs	F2-168- 3200-VA
3.700 mm	F2-168- 3700-vs	F2-168- 3700-VA
4.200 mm	F2-168- 4200-vs	F2-168- 4200-VA
4.600 mm	F2-168- 4600-vs	F2-168- 4600-VA
5.200 mm	F2-168- 5200-vs	F2-168- 5200-VA
6.000 mm	F2-168- 6000-vs	F2-168- 6000-VA
7.000 mm	F2-168- 7000-vs	F2-168- 7000-VA
8.000 mm	F2-168- 8000-vs	F2-168- 8000-VA
9.000 mm	F2-168- 9000-vs	F2-168- 9000-VA
10.000 mm	F2-168-10000-vs	F2-168-10000-VA
11.000 mm	F2-168-11000-vs	F2-168-11000-VA
12.000 mm	F2-168-12000-vs	F2-168-12000-VA

Accessories	Steel	Stainless steel	
Cage*	800 x 800 mm	RWK-800-F168-St	RWK-800-F168-VA
Cage*	1000 x 1000 mm	RWK-1000-F168-St	RWK-1000-F168-VA
Blade**	Ø 700 mm	FL-700-F168-St	FL-700-F168-VA
Blade**	Ø 750 mm	FL-750-F168-St	FL-750-F168-VA
Blade**	Ø 800 mm	FL-800-F168-St	FL-800-F168-VA
Blade**	Ø 850 mm	FL-850-F168-St	FL-850-F168-VA
Skid reinforced		Kufe-F168-vs	Kufe-F168-VA
Rigid D-frame galvanised, available in different lengths on request			
Support bracket width 800 mm	Z-Halterung-800-vs	Z-Halterung-800-VA	
Support bracket width 1000 mm	Z-Halterung-1000-vs	Z-Halterung-1000-VA	
Oil expansion tank stainless steel 06 litres for wall mounting		Z-Oil tank-06	
Oil expansion tank stainless steel 06 litres for mounting on pipe		Z-Oil tank-07	
Oil expansion tank stainless steel 12 litres for wall mounting		Z-Oil tank-08	
Oil expansion tank stainless steel 12 litres for mounting on pipe		Z-Oil tank-09	

* Please indicate cage clearance, price on request

** Please state the desired flow direction (suction or pushing), price on request

Mixers for elevated tanks

Please see the installation instructions for technical specifications. Required aperture in the silo wall is 210 x 210 mm.

In the case of the stainless steel version, only those components that come into direct contact with the slurry are manufactured of stainless steel.

For mixers that are installed on the floor angle plane we recommend the fitting of an oil expansion tank for optimum lubrication of the upper seal.

When only used occasionally, the standard model with shaft seal rings will be adequate. For prolonged operational periods we recommend using a mechanical seal.

Technical specifications:

Pusher propeller: Ø 600 mm, options up to Ø 700 mm; overall length: 3200 mm; PTO connection: 1 3/8" Z6 DIN 9611; propeller speed: max. 1000 rpm; power requirement: 44-118 KW (60-160 hp); bearings: roller bearings in oil bath;

connector for installed mixer to be selected according to the silo type without price supplement.

Type HEM 1 installed mixer

Installed mixer directly flanged to the silo wall, with two external supports and seal. It is recommended that they are installed in steel containers. Internal supports supplied separately, required for propeller diameters over 600 mm.

Galvanised, length 3200 mm	HEM-1-vs
Stainless steel, length 3200 mm	HEM-1-VA
Price supplement	
Mechanical seal SiC/SiC with oil filling	A-Preis-015
Turbo mixing propeller Ø 600 mm	A-Preis-021

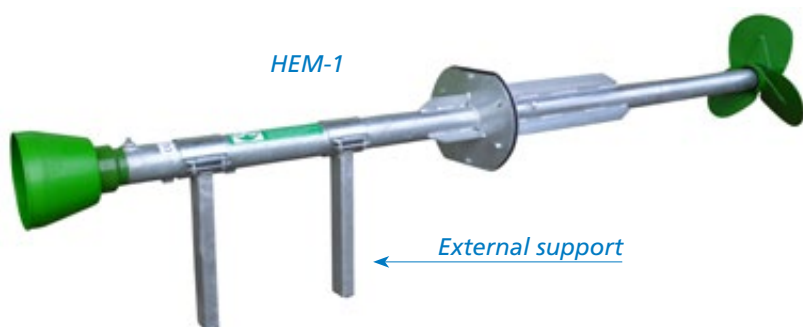

Type HEM 2 installed mixer

Installed mixer with vibration-damped seal in the wall area, complete with 2 external supports, one internal support and the seal carrier assembly with the required seals.

Galvanised, length 3200 mm	HEM-2-vs
Stainless steel, length 3200 mm	HEM-2-VA
Price supplement	
Mechanical seal SiC/SiC with oil filling	A-Preis-015
Turbo mixing propeller Ø 600 mm	A-Preis-021



Accessories

Internal support

Galvanised	Z-HEM-001
Stainless steel	Z-HEM-002

Mixing nozzle separate, for HEM 3

Galvanised	Z-HEM-003
Stainless steel	Z-HEM-004

Retrofit kit:

Adjustable mixing nozzle for mixer HEM 3	Z-HEM-005
--	-----------

Universal retrofit kit or mixers HEM 1 or 2	Z-HEM-006
Equipment is the same as for the HEM 4 machine	

Oil expansion tank with 1/2" thread	Z-Ölbehälter-01
-------------------------------------	-----------------

Sacrificial anode with galv. bracket	Z-Opferanode-01
Sacrificial anode with stainl. steel bracket	Z-Opferanode-02

Type HEM 3 installed mixer

Installed mixer in accordance with type HEM 2, but with one mixing nozzle and one external support.

Galvanised, length 3200 mm	HEM-3-vs
Stainless steel 3200 mm	HEM-3-VA
Price supplement	
Mechanical seal SiC/SiC with oil filling	A-Preis-015
Turbo mixing propeller Ø 600 mm	A-Preis-021

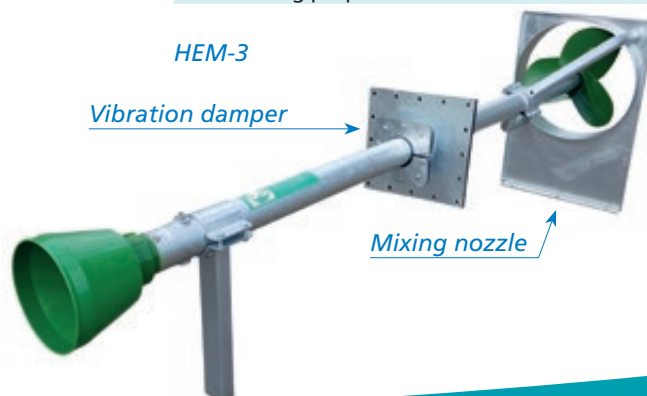

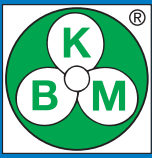

Mixers for elevated tanks

HEM 6 installed mixer

During the mixing process, the agitation jet can be directed in the desired flow direction thanks to a mixing nozzle that can rotate 360°. This makes it possible effectively counteract any floating or sinking layers that may arise. The special characteristic of the HEM-6 mixer is that it does not require an external foundation and the rotation is adjusted via the mixer tube. All axial forces are absorbed by the four stands into which the mixer is guided. The standard version requires a flat installation space. Suitable connecting flanges for all slurry tank types can be supplied at short notice on request. The mixer nozzle

ring is divided. As a result, the mixer can be easily taken into the tank for assembly through a manhole with an internal diameter of 800 mm. Permanent formwork can be supplied for installation in a concrete tank.

When only used occasionally, the standard version with shaft seal rings is sufficient. For prolonged operational periods, we recommend fitting the mixer with a mechanical seal and modular shafts for a price supplement (A-Preis-015) (retrofitting not possible).

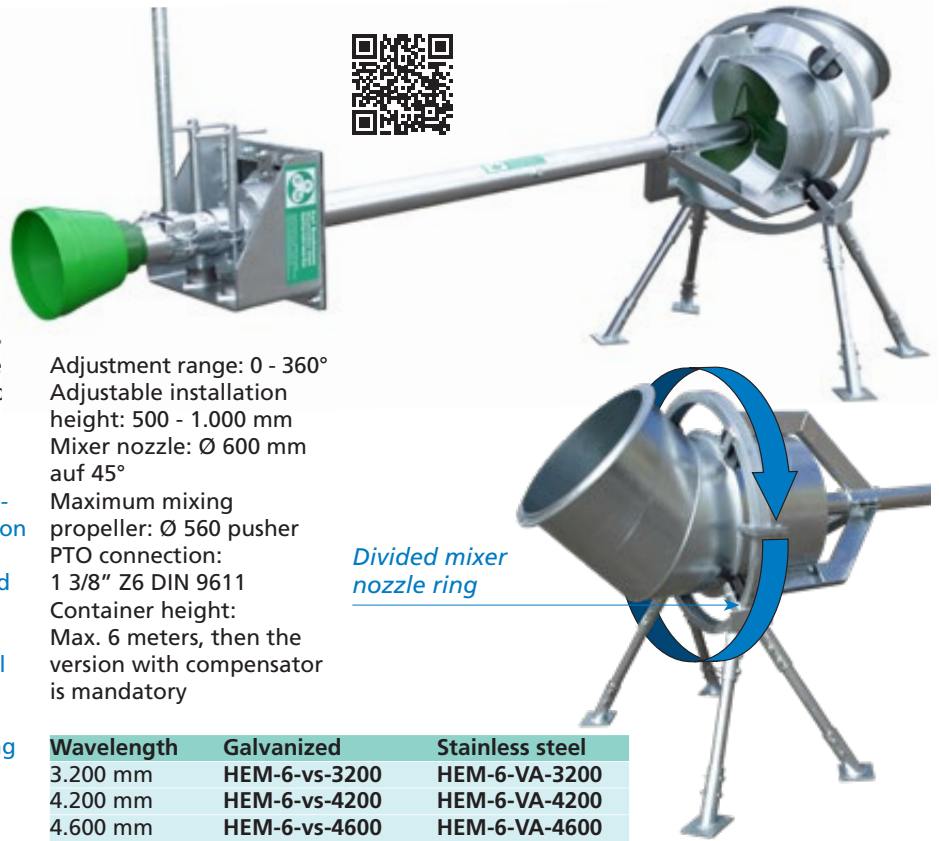

Adjustment range: 0 - 360°
Adjustable installation height: 500 - 1.000 mm
Mixer nozzle: Ø 600 mm auf 45°
Maximum mixing propeller: Ø 560 pusher
PTO connection: 1 3/8" Z6 DIN 9611
Container height: Max. 6 meters, then the version with compensator is mandatory

Divided mixer nozzle ring

Wavelength	Galvanized	Stainless steel
3.200 mm	HEM-6-vs-3200	HEM-6-VA-3200
4.200 mm	HEM-6-vs-4200	HEM-6-VA-4200
4.600 mm	HEM-6-vs-4600	HEM-6-VA-4600
5.200 mm	HEM-6-vs-5200	HEM-6-VA-5200
6.000 mm	HEM-6-vs-6000	HEM-6-VA-6000

The standard wavelength is 3,200 mm

Price supplement		
Mechanical seal SiC/SiC with oil filling	A-Preis-015	
Turbo mixer propeller Ø 560 mm	A-Preis-019	

Angle bracket

A 10° or 20° angle bracket for installing the mixer can be supplied for mixing a tank that is built into the ground even when the fill level is low. An oil expansion tank is also required due to the floor angle.



	10° bracket	20° bracket
Galvanised	Z-HEM-09	Z-HEM-11
Stainless steel	Z-HEM-10	Z-HEM-12



Concrete formwork

The permanent concrete formwork simplifies the final assembly. The shaft lining contains all the threaded sleeves that make it easier to attach the HEM-6 wall plate. Due to the different hole dimensions, it must be specified when ordering whether the HEM-6 agitator is to be ordered with a standard wall bracket

or in the compensator version. As an alternative to the simple concrete formwork, a version with a masonry collar of 150 mm is available (article Z-HEM-013 + Z-HEM-014). All concrete formwork cannot be retrofitted.



	Concrete formwork	with wall collar
Galvanised	Z-HEM-07	Z-HEM-13
Stainless steel	Z-HEM-08	Z-HEM-14

Price supplement: compensator version

For tank heights greater than 6 metres, a compensator is required instead of the normal mounting bracket. The compensator can be submerged up to 20 metres (up to 100 metres as a special version). Thanks to an angle adjustment device in the

wall bracket, the installation can be adjusted easily at a constant floor angle of 0° to 20°. This also facilitates installation. This version is available for a price supplement on the basic unit.

We recommend fitting the HEM-6 mixer in the version with the mechanical seal and modular shaft technology for a price supplement.

An oil expansion tank for wall mounting is required for mixers that are installed at floor angle.

Price supplement on the HEM-6 standard mixer, galvanised	A-Preis-025
Price supplement on the HEM-6 standard mixer, stainless steel	A-Preis-027

Mixers for elevated tanks

Price supplement: reinforced mixer nozzle

A 45° reinforced mixer nozzle made of 8 mm sheet steel is available for a price supplement on the HEM-6 standard mixer. This is especially recommended if there is a high level of sand in the slurry. On request, the reinforced nozzle is

also available with a 60° nozzle angle. This can be advantageous if, for example, the mixer is to be installed at a 20° floor angle in an elevated tank.

We recommend also fitting the HEM-6 mixer with a mechanical seal

and modular shafts for a price supplement (A-Preis-015).

An oil expansion tank for wall mounting is required for mixers that are installed at floor angle.

Price supplement on the HEM-6 standard mixer, galvanized	A-Preis-026
Price supplement on the HEM-6 standard mixer, stainless steel	A-Preis-028

External drive unit

The external drive unit makes it possible to operate a tractor mixer by electric drive and it can be delivered and put into use later on. The height and tilt angle of the drive axle can be adjusted whereby the drive can be installed in alignment with the mixer axle. A drive shaft with wide-angle joint is thus not necessary, since there is only slight angulation of the joints. Standard connection size 1 3/8" Z6 DIN 9611 (1 3/4" Z6 also available on request). There are two versions to choose from:

For the compact drive with gear motor, an optional sliding device is also available to operate the by tractor drive as an alternative. The version with a V-belt drive is fitted with a PTO connection by the factory for tractor use. It should be noted that in this case the electric motor must be mechanically separated by removing the V-belts. Automatic time interval controls with soft start as well as a cardan drive shaft are available as accessories.

We recommend the use of a frequency converter so that at any time all the components can be ideally matched to each other and adapted to the existing operating conditions.

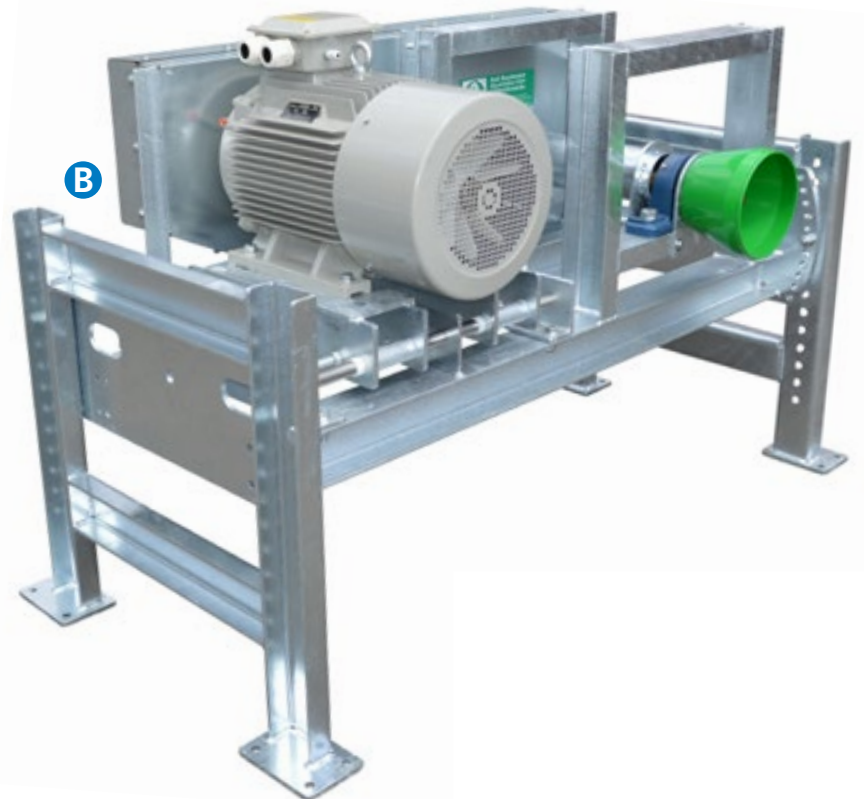
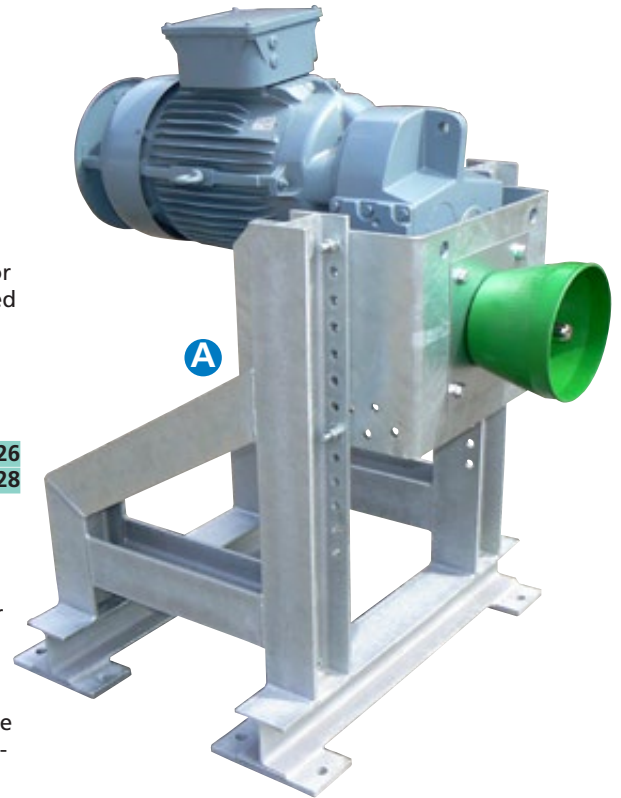

A Drive unit with gear motor

B Drive motor with V-belt drive

External drive unit without drive shaft

Gear motor 11.0 kW	ATE-110-GM
Gear motor 15.0 kW	ATE-150-GM
Gear motor 18.5 kW	ATE-185-GM
Gear motor 22.0 kW	ATE-220-GM
Gear motor 30.0 kW	ATE-300-GM

V-belt drive 11.0 kW	ATE-110-KM
V-belt drive 15.0 kW	ATE-150-KM
V-belt drive 18.5 kW	ATE-185-KM
V-belt drive 22.0 kW	ATE-220-KM
V-belt drive 30.0 kW	ATE-300-KM
V-belt drive 37.0 kW	ATE-370-KM
V-belt drive 45.0 kW	ATE-450-KM
V-belt drive 55.0 kW	ATE-550-KM
V-belt drive 75.0 kW	ATE-750-KM

Cardan drive shaft without wide-angle G-8

Type CS8N 086 CE 007 007	
Total length	min. 1110 mm
Cross/Cross	min. 860 mm
Connection size	1 3/8" Z6
Performance limit	100 kW (136 hp) at 1000 rpm

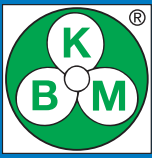

Mixers for elevated tanks



HEM-7

Type HEM 7 installed mixer

The Type HEM-7 range of mixers is intended as a replacement mixer for the Duräumat Silomix. This separate range means that the complicated conversion to different bracket designs is not required. The existing connections and flanges can be utilised.

Scope of supply:

- Type HEM oil-filled mixer tube, ready for use
- Mixing propeller Ø 600 - pusher
- Protective cone for the PTO shaft

Galvanised, length 2000 mm	HEM-7-vs
Stainless steel, length 2000 mm	HEM-7-VA

Price supplement

Mechanical seal SiC/SiC with oil filling	A-Preis-015
Turbo mixing propeller Ø 600 mm	A-Preis-021

Type HEM 8 installed mixer

This is also a replacement mixer for the Duräumat Silomix. Following technical clarification a corresponding mounting plate will be manufactured. Sealing of the mixer tube is achieved using a squeeze plate seal in the mounting plate. Normally, the old external supports can be re-used. New external supports can be supplied upon request.

Scope of supply:

- Type HEM oil-filled mixer tube, ready for use
- Mixing propeller Ø 600 - pusher
- Protective cone for the PTO shaft
- Mounting plate with welded-on tube
- Squeeze plate seal

Galvanised, length 2200 mm	HEM-8-vs
Stainless steel, length 2200 mm	HEM-8-VA

Price supplement

Mechanical seal SiC/SiC with oil filling	A-Preis-015
Turbo mixing propeller Ø 600 mm	A-Preis-021



HEM-8

Illustration shows the special equipment, mechanical seal

Due to the seal length of 100 mm, it cannot be installed in the core hole with a diameter of 200 mm at an angle or askew.



Press-seal plates

Effektive principle: Squeeze

Solid rubber boot with stainless steel fittings and stainless steel press plates of diameter 102 mm.

Outside diameter:	Ø 200 mm
Inside diameter:	Ø 102 mm
Length of the seal:	100 mm

Order no.: Z-Dichtung-001

Mixers for elevated tanks

Type Super HEM 6

The mixing principle corresponds to the standard mixer type HEM-6. The mixer nozzle can be pivoted through 360° from the exterior. Recommended for tractor power from 250 kW (340 hp).



An oil expansion tank must be fitted for mixers that are installed on the floor angle plane. To ensure optimum oil level checking, this tank is generally available as an accessory for every unit.



Accessories:

Large volume oil expansion tank for wall mounting

Technical details:

- Compact pusher propeller Ø 850 mm (alternatively Ø 700, Ø 750, Ø 800)
- Mixer nozzle Ø 920 mm set to 45°
- Mixer tube Ø 168.3 mm in 4200 mm construction length
- Multiple ball bearing shaft Ø 45 mm in oil bath
- Power take-off shaft 1 3/4 inches Z6 DIN 9611
- Low-wear mechanical seal SiC/SiC for long service life
- Compensator 20 meters floodable (as special construction up to 100 meters)
- Installation up to 20° floor angle plane possible
- Version either galvanised or in stainless steel
- Standard shaft length 4200 mm; 3200 mm to 9000 mm available on request

Stirring nozzle 360° swiveling

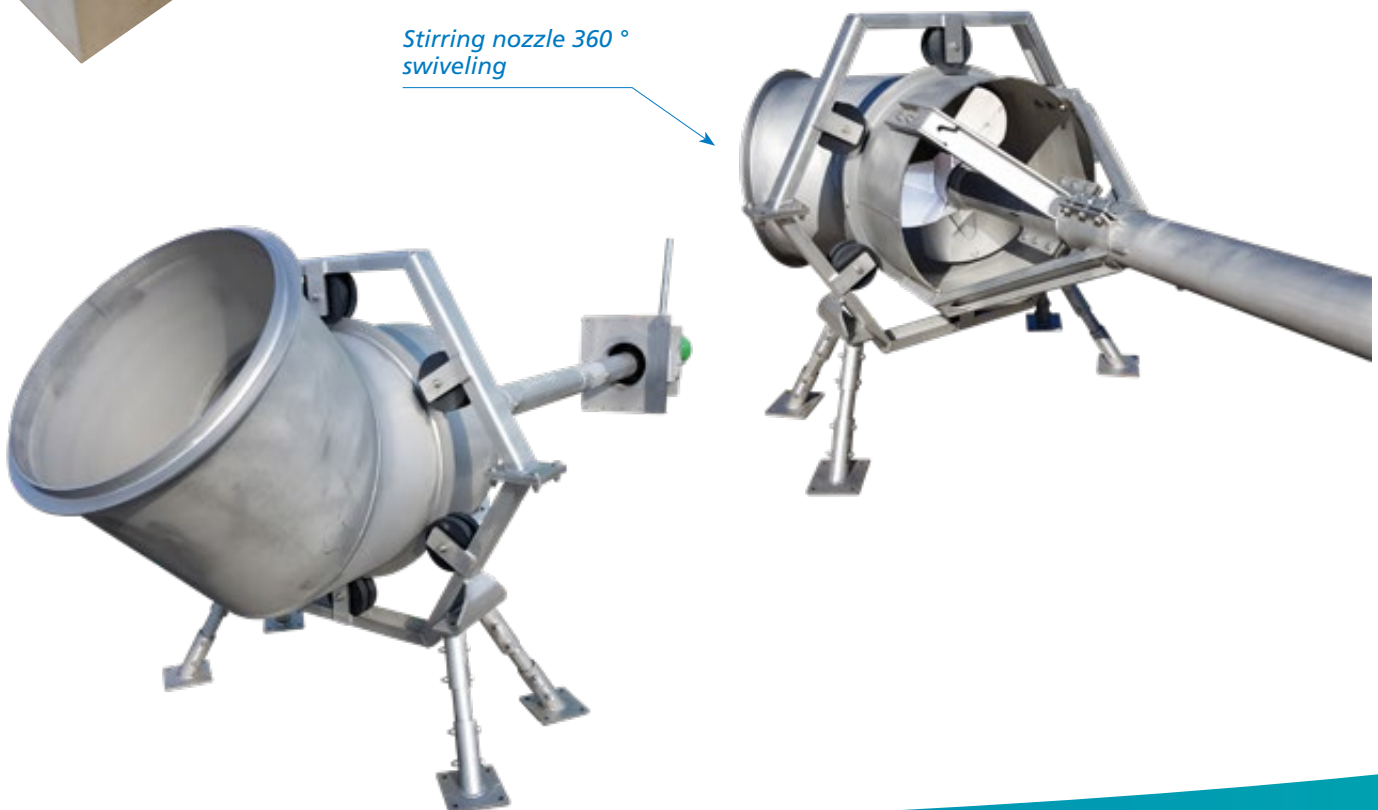



Mixers for elevated tanks

Direct comparison: HEM-6 and Super HEM-6

Super HEM-6

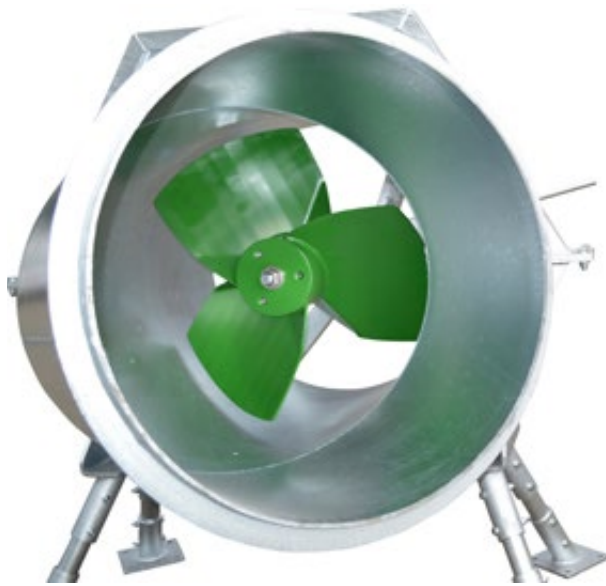

HEM-6

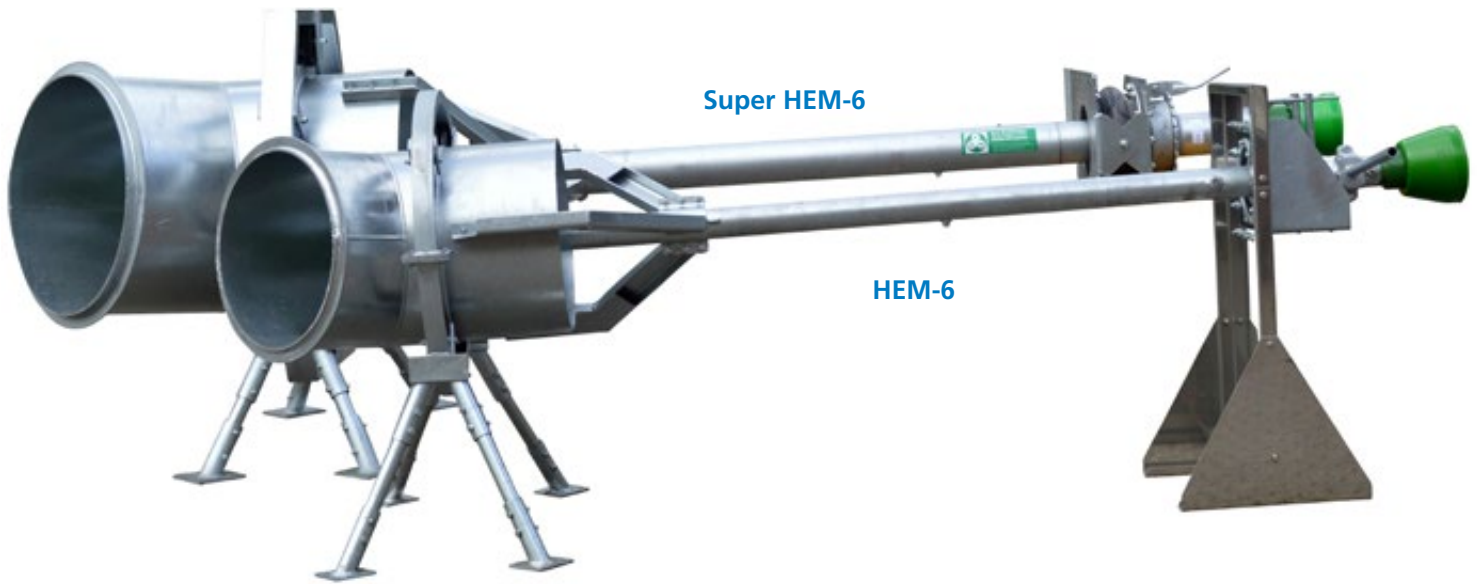

Super HEM-6

HEM-6

Super HEM-6

HEM-6

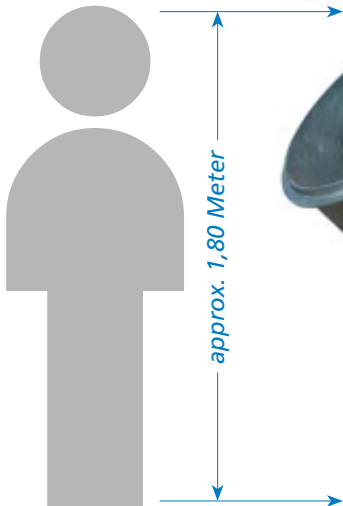

approx. 1,80 Meter



Electric mixers for elevated tanks

Type Biogas 1031 electric installed mixer

The type 1031 biogas mixers are fitted with an electric drive and V-belt gear reduction that protects the drive motor and is fitted with a belt tensioning system. The V-belt not only offers maximum protection for the drive motor; it also protects against breakage of the drive shaft should the mixing propeller become obstructed by a foreign object. 6-pole motors with a speed of 1000 rpm and an output of 7.5–22.0 kW are used as the drive motor in this design. Depending on the size, the high-torque electric motors make it possible to reach mixing propeller speeds between 300 and 400 rpm. Thanks to the high torque, propeller diameters of 500–600 mm are possible.

The efficiency is significantly greater than with the standard electric motor 1450 rpm. Supplied as standard with a pusher propeller without a switch or interval control. The mixer can be retrofitted with an angled drive making it suitable for virtually any application. The mixer is supplied as standard with a pusher propeller but excluding switch and interval timer control. The mixer can be retrofitted with an angled drive making it suitable for virtually any application. The three-part drive shaft is of a modular design. The upper and lower sections of the drive shaft are fitted with 2 taper roller bearings each, while the centre shaft section has a deep groove ball bearing. The maximum bearing spacing is 1500 mm.

The mixer is oil filled is of a very low maintenance design and can be used

for continuous operation, 24/7, up to 1000 rpm. The drive shaft is sealed by means of a SiC/SiC mechanical seal. The front drive shaft is sealed using a cartridge seal. The special seal is moisture proof. Air humidity and rain ingress are therefore no longer an issue. The front drive shaft is equipped with a PTO spline in accordance with 1 3/8" Z6 DIN 9611 which enables combined electric/tractor drive operation. If a tractor is used, the V-belts must be removed. If the unit is installed at floor angle, an oil expansion tank must be installed and the oil refilled.



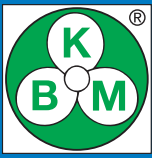

Mixer system for biogas digesters

Application: Fermenter

- The mixer can also be installed and removed with a full tank
- The biogas digester can continue operating with no down-time
- The installation and removal of our mixing system can be completed from the outside without it, being

necessary for a fitter to get inside the tank.

- The medium can be fed into the tank during mixing and is immediately and completely mixed through
- Trouble-free stirring and mixing is ensured because there is no installed equipment to interrupt the flow
- Can be used in all types of tank

- The mixer is not located in an explosion protection area
- Can also be retrofitted to all existing systems

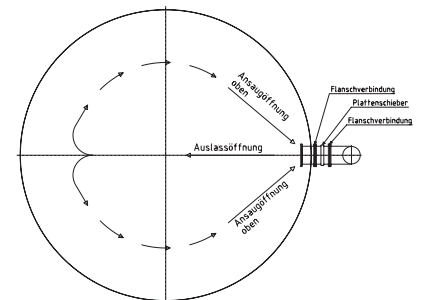
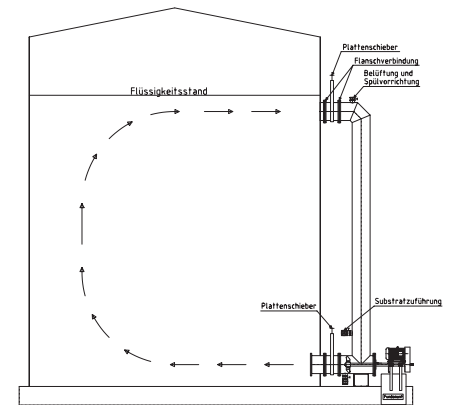
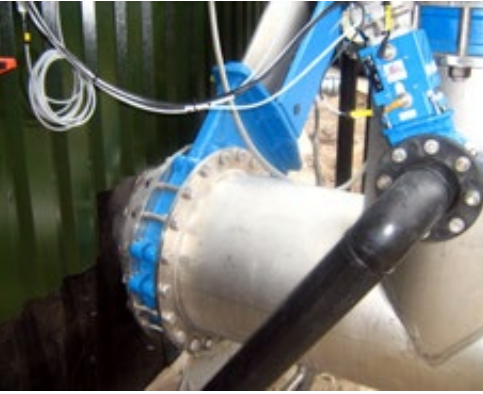

Paddel-Profi – the whispering giant



The Paddel-Profi is characterised by its robust construction. Specially developed for daily operation in biogas digesters, it has now become an indispensable piece of equipment. Its four large mixing paddles mix the medium at low speed in a biologically sensitive manner. Even if the DS values are higher than usual the Paddel-Profi simply continues working, thanks to its high-torque drive.

The maxim here is “less is more”. A lower mixer shaft speed – but better mixing of the medium thanks to the large mixing paddles.

The mixer shaft is installed horizontally and in a tank mounted on a frame made of steel girders. The exterior of the Paddel-Profi is fixed to the silo. An over-sized ball bearing and a mechanical seal on the external mounting, together with a low-maintenance slide bearing on the steel frame inside the tank, ensure a long service life with minimum wear. Once the Paddel-Profi has been installed, no further adjustment work is necessary.

The driving element is a slow-running motor (standard version 15 kW / optional 18.5 kW), geared down with a planetary gear.

Its excellent efficiency means that power consumption is significantly lower than with conventional mixers.

The Paddel-Profi – a whispering giant

The main advantages at a glance

- The drive system is accessible from outside.
- No cables or chains inside the tank
- Low shaft speed is biologically sensitive
- Four large paddles staggered alternately from side to side, ensure thorough mixing
- Good efficiency lowers power consumption
- Keeps running even at increased DS values
- Heavy-duty bearings and mechanical seal for long service life
- Robust steel construction
- No subsequent adjustment work to the mixer is necessary
- Designed for daily operation in biogas digesters



Mounting on all tank types made of steel possible. Corresponding lower stay members can be supplied.



The agitator can also be supplied with a flat gear motor.

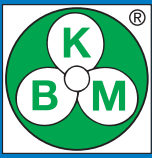

Angle-adjustable installed mixer

Fermix type

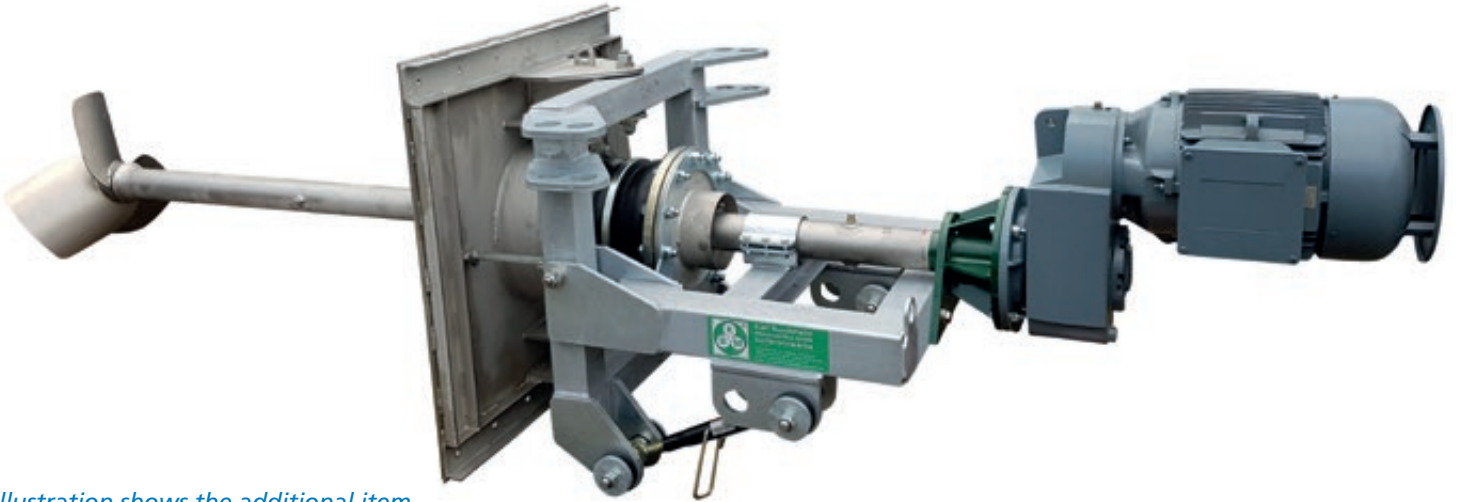

Illustration shows the additional item "angle-adjustable through-wall installation frame" and stainless steel version



The compensator can be submerged up to 20 metres (up to 100 metres as a special version), and so the mixer can also be installed at the bottom of any tank. The corresponding installation components can be manufactured.

The mixer can be installed or removed from the outside without a person having to work in the tank.



The Fermix can be supplied with geared motors of 7.5 kW to 22.0 kW.

The gearbox transmits a high level of torque to the mixing paddles. Depending upon the version, the paddle speed is 300 – 400 rpm.

Standard equipment:

- Mixer tube Fermix type, standard length 3200 mm, galvanised
- Sealed with SiC / SiC mechanical seal
- Taper roller bearings/ roller bearings in oil bath
- Mixing propeller, pusher
- Geared motor

Additional items and special equipment

- Concrete formwork for the through-wall installation frame, galvanised or stainless steel
- Fixed, non-adjustable through-wall installation frame
- Angle-adjustable through-wall installation frame with compensator for up to 20°
- Geared motor with ATEX approval
- Geared motor - special voltage
- Mixer lengths up to 5200
- Manhole
- External mounting for fastening to steel tank
- Components that come into contact with the medium are made of stainless steel
- Hydraulic motor
- Oil Reservoirs made of PVC or stainless steel

Angle-adjustable installed mixer

Fermix-Flex

The Fermix-Flex is supplied with a high-torque electric motor and V-belt drive. The big advantage is that the mixer can be used with a tractor at up to 1,000 rpm in continuous operation any time after the V-belt has been removed. A precon-

dition is that the device is installed near the ground.

A special compensator allows an angle adjustment of 28° in all directions and can be submerged up to 20 metres (up to 100 metres as a special version).

Depending on the engine power, the propeller speed is 330 – 400 rpm. The standard shaft length is 3,200 mm.

The wall plate, like the Fermix, has reinforced U-profiles for even more stability. The inclination is

adjusted using two upper links which are mounted directly on the wall frame. All upper links are vibration-dampened with rubber inserts.



Basic equipment:

- Wall frame galvanised, angle-adjustable with special compensator
- Mixer module galvanised, shaft length 3,200 mm with electric motor and drive elements
- Mixing propeller Ø 500 – Ø 600 (depending on drive) pusher

- Module shafts in oil bath
- At least 5 ball bearings, even more depending on the device length, no sliding bearings!
- Sealing through SiC/SiC mechanical seal

Additional parts and special equipment:

- Permanent concrete formwork made of galvanised steel or stainless steel
- Electric motor with ATEX approval
- Electric motor with special voltage
- External support for mounting on the steel tank

- Parts that come into contact with the medium made of stainless steel
- Oil expansion tank made of stainless steel

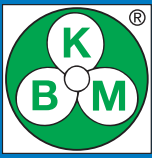

Super-Fermix

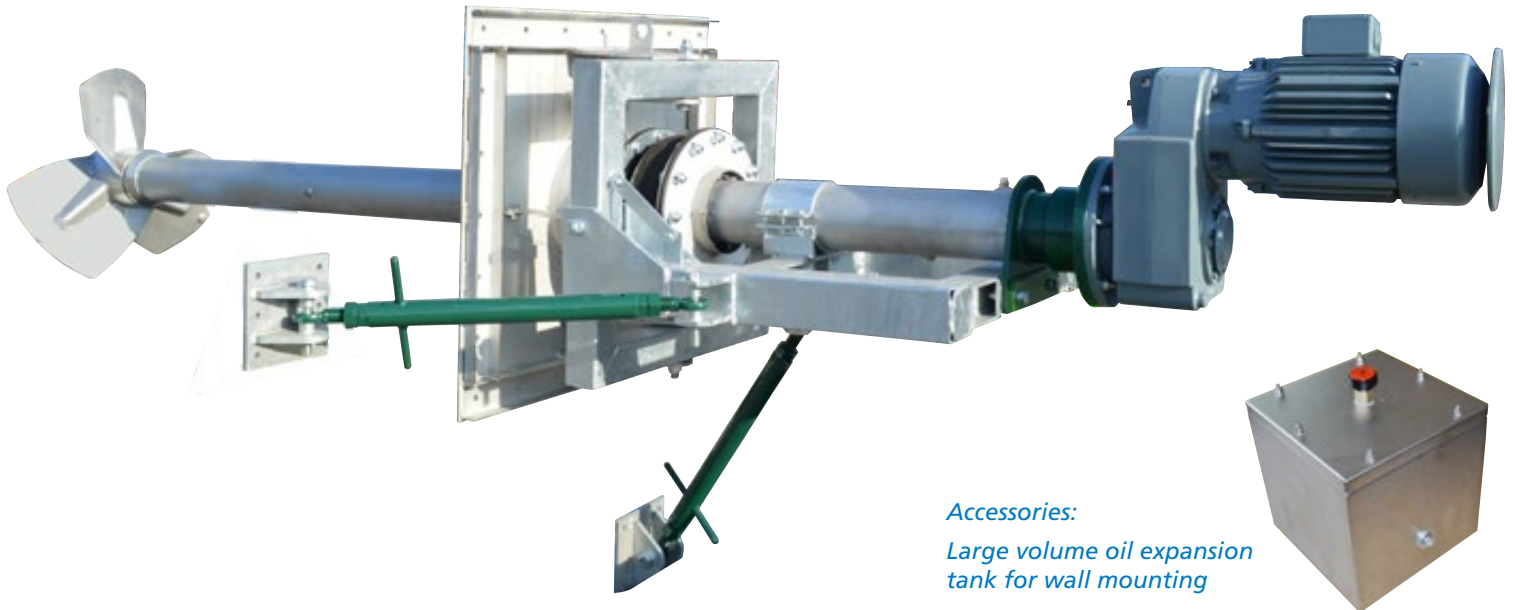

Accessories:

Large volume oil expansion tank for wall mounting



Super-Fermix

The Super-Fermix is a further development of the proven Fermix installed mixer with a heavy duty mixer tube, a larger propeller and higher mixing efficiency. The compensator can be submerged up to 20 metres (up to 100 metres as a special version), and so the mixer can also be installed at the bottom of any tank.

The mixer can be installed or removed from the outside without a person having to work in the tank.

Basic equipment:

- Reinforced mixer tube with a diameter of 168.3 mm
- Standard shaft length 4200 mm
- Massive 850 mm diameter propeller
- Ball bearing supported modular shafts in the oil bath
- Sealing by mechanical seal
- Electric motor 15.0 kW to 30 kW with gear stage

Additional items and special equipment:

- Wall mounting frame adjustable in angle with compensator up to 20°.
- Fixed wall mounting frame
- Concrete formwork or manhole in galvanised or stainless steel
- Electric motor with gear stage in ATEX version
- Electric motor for a special voltage
- Mixer shaft length up to 6000 mm
- Components in contact with medium in stainless steel
- Oil Reservoirs made of stainless steel

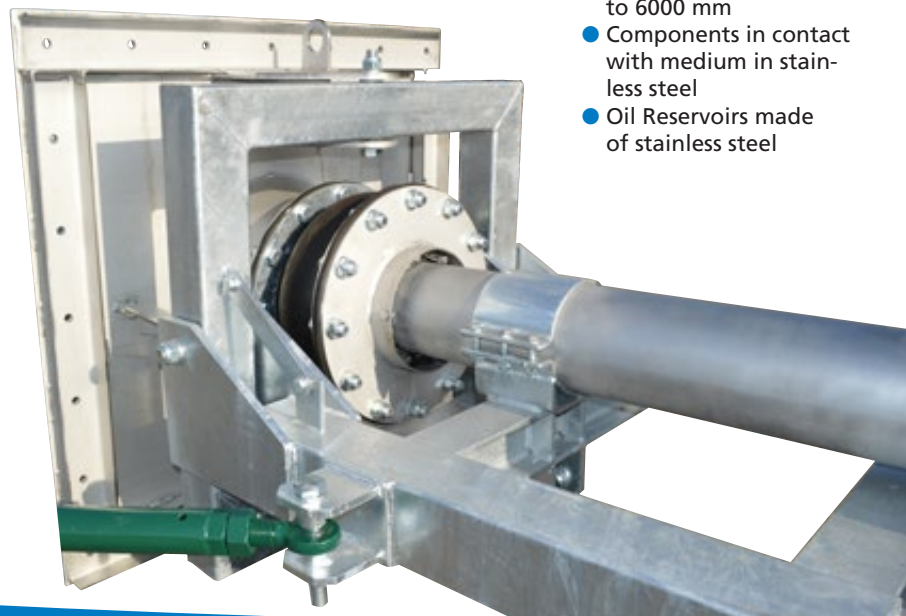

Centro-Mix



Central mixer Typ Centro-Mix

Motor sizes 7.5 kW to 45 kW
Shaft lengths up to 19,500 mm

Special feature: Bearings, safety monitoring devices and all externally located wearing parts can be replaced with the tank filled, without the entire mixer having to be removed.





BoBuMix-168

large propeller mixer

BoBuMix-168

the rugged version with the large mixing propeller

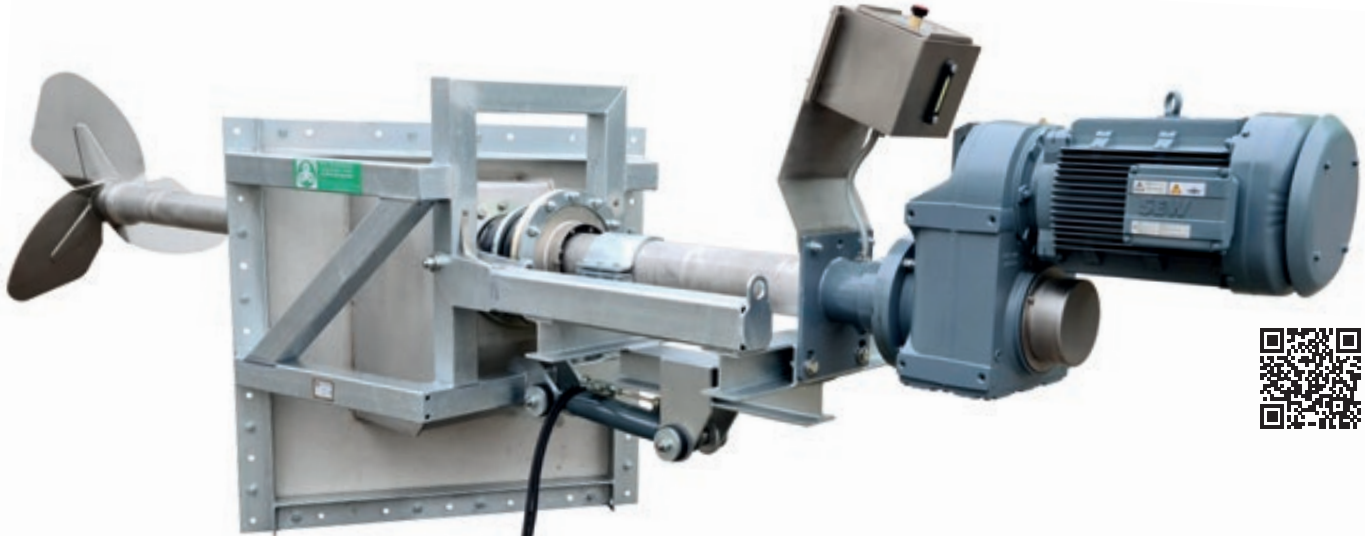

Optionally
with
hydraulic tilt
adjustment



The BoBuMix-168 is a large propeller mixer specially designed for use in fermenters and secondary fermenters in biogas digesters and a further development of the well-known BoBuMix mixer. The large, form-optimised mixing propeller ensures rapid mixing in the shortest time, with low power consumption.

The drive unit is a quiet, high-quality motor with an ATEX-design gear stage.

Components that come into contact with the medium are made of stainless steel. Thanks to a flexible compensator, which is mounted and sealed on the bearing block, the inclination can be infinitely adjusted between +/- 20°. Version for ceiling and wall mounting (orientation 30° left or 30° right) available.

Thanks to the large concrete formwork (optional) opening, the mixer can be installed or removed in one go without anyone having to work inside the fermenter.

Advantages at a glance

- Fast and easy assembly
- Maintenance-friendly design
- The materials are matched to the application
- All mechanical components are outside the tank
- A large mixing propeller with a diameter of 1400 mm and a low speed of approx. 90–150 rpm ensure gentle mixing of the medium in a biologically sensitive manner inside the fermenter
- Inclination continuously adjustable at any time
- Motor output of 11–30 kW available
- Quiet, high-quality drive unit with ATEX design
- Swivel range device wall mounting: Height: horizontally up to 40° to the floor, zero position at 20° floor inclination
- Swivel range device ceiling mounting: Height: + 20° up - 20° to the ground
- Can be retrofitted on existing systems (following consultation)
- Concrete formwork for easy mixer installation available
- The compensator is up to 20 meters floodable (as special construction up to 100 meters)
- Low-wear SiC/SiC mechanical seal for a long service life
- Ball-bearing-mounted modular shafts in the oil bath
- Mixer tube with a diameter of 168.3 mm in a reinforced design
- Inclination adjustment via spindle, optionally also hydraulically with hand pump

An oil expansion tank is absolutely necessary due to the pivot possibilities. This can be supplied as an accessory by the factory or ordered by this customer.

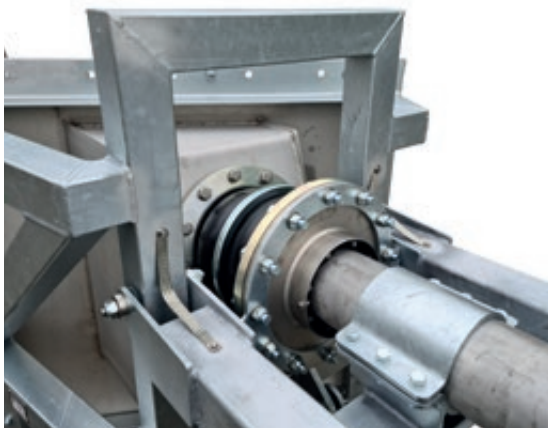

BoBuMix-168 large propeller mixer



Lower stand member wall construction for use in a steel tank. A consultation is first required to clarify technical details.



Concrete formwork for easier assembly



The complete previous BoBuMix type design is still available on request.



Illustration shows special equipment

Existing BoBuMix mixers can also be retrofitted to the new design.

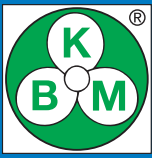

Type L-E2 electric mixer

The Type L-E2 electric mixer is fitted with an electric motor. The outside tube, drive shaft and bearing dimensions are the same as for the E2-102.

For oil-filled mixers we recommend the fitting of an oil expansion tank to ensure optimum lubrication of the upper seal.

The mixer is driven by the side-mounted electric motor via an elastic V-belt gear reduction that protects the motor and is fitted with a belt tensioning system. (Mixing propeller speed 516 rpm). The mixer is fitted with a large motor cowling that allows fast access to the belt drive via a pivot point. Sufficient air circulation is ensured for cooling the motor.

The Star-Delta reversing circuit fitted to the motor (with CEE device plug) allows use as a suction or pusher mixer.

Electric mixers of the L-E2 range can be quickly converted to an annular channel mixer by attaching a propeller cage. Using this method, mixer lengths of up to 1200 mm can be supplied. A wheeled chassis is available for transporting the mixer.

The lengths 4200, 4600, 5200 and 6000 are preferred, with motor ratings of 15 and 18.5 kW

While all other lengths are listed and can be supplied, these are considered custom-made products. Custom-made products cannot be exchanged!

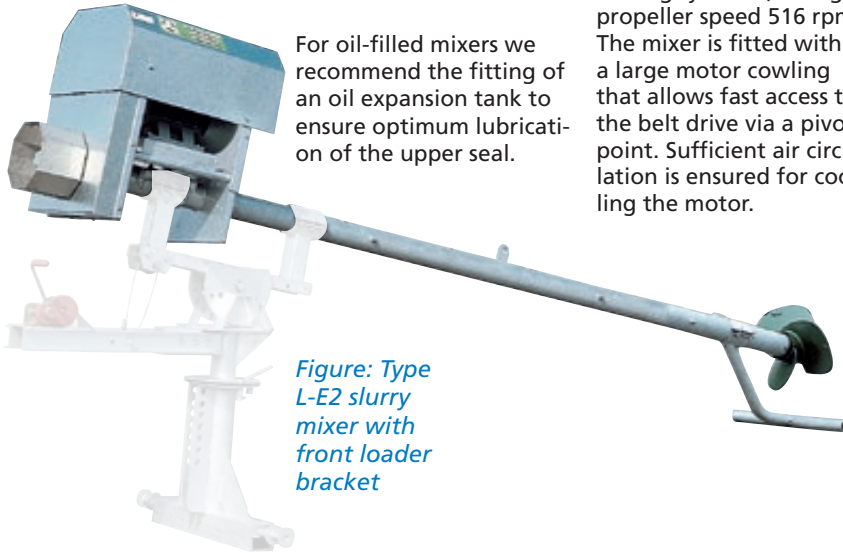

Figure: Type L-E2 slurry mixer with front loader bracket

Electric slurry mixer Type L-E2 (516 rpm)

Includes 1 installed switching unit with CEE device plug, star-delta reversing switch, motor protection circuit breaker and undervoltage trip. Shaft bearing: Maintenance-free roller bearing. All mixer types include 1 propeller skid. Outside tube Ø 102 mm

Mixer type	Motor-rating kW	Standard mixer lengths: dimension value = mixer shaft length							Mixing propeller
		1.750 mm Order no.	2.250 mm Order no.	2.750 mm Order no.	3.250 mm Order no.	3.700 mm Order no.	4.200 mm Order no.		
L-E2-055	5,5	L-E2-055-1750	L-E2-055-2250	L-E2-055-2750	L-E2-055-3250	L-E2-055-3700	L-E2-055-4200	Ø 360-Push	
L-E2-075	7,5	L-E2-075-1750	L-E2-075-2250	L-E2-075-2750	L-E2-075-3250	L-E2-075-3700	L-E2-075-4200	Ø 380-Push	
L-E2-110	11,0	L-E2-110-1750	L-E2-110-2250	L-E2-110-2750	L-E2-110-3250	L-E2-110-3700	L-E2-110-4200	Ø 400-Push	
L-E2-150	15,0	L-E2-150-1750	L-E2-150-2250	L-E2-150-2750	L-E2-150-3250	L-E2-150-3700	L-E2-150-4200	Ø 420-Push	
L-E2-185	18,5	L-E2-185-1750	L-E2-185-2250	L-E2-185-2750	L-E2-185-3250	L-E2-185-3700	L-E2-185-4200	Ø 440-Push	
L-E2-220	22,0	L-E2-220-1750	L-E2-220-2250	L-E2-220-2750	L-E2-220-3250	L-E2-220-3700	L-E2-220-4200	Ø 460-Push	

Mixer type	Motor-rating kW	Standard mixer lengths: dimension value = mixer shaft length							Mixing propeller
		4.600 mm Order no.	5.200 mm Order no.	6.000 mm Order no.	7.000 mm Order no.	8.000 mm Order no.	9.000 mm Order no.		
L-E2-055	5,5	L-E2-055-4600	L-E2-055-5200	L-E2-055-6000	L-E2-055-7000	L-E2-055-8000	L-E2-055-9000	Ø 360-Push	
L-E2-075	7,5	L-E2-075-4600	L-E2-075-5200	L-E2-075-6000	L-E2-075-7000	L-E2-075-8000	L-E2-075-9000	Ø 380-Push	
L-E2-110	11,0	L-E2-110-4600	L-E2-110-5200	L-E2-110-6000	L-E2-110-7000	L-E2-110-8000	L-E2-110-9000	Ø 400-Push	
L-E2-150	15,0	L-E2-150-4600	L-E2-150-5200	L-E2-150-6000	L-E2-150-7000	L-E2-150-8000	L-E2-150-9000	Ø 420-Push	
L-E2-185	18,5	L-E2-185-4600	L-E2-185-5200	L-E2-185-6000	L-E2-185-7000	L-E2-185-8000	L-E2-185-9000	Ø 440-Push	
L-E2-220	22,0	L-E2-220-4600	L-E2-220-5200	L-E2-220-6000	L-E2-220-7000	L-E2-220-8000	L-E2-220-9000	Ø 460-Push	

Accessories	Order no.
Front loader bracket with transverse pivoting system	Z-Halterung-005
Elevated tank mixer bracket, for stationary operation	Z-Halterung-006
Hydraulik tilt adjustment integrated into front loader bracket, price supplement on basic unit	Z-Hydraulik-001
Wheeled chassis for the slurry mixer Type L-E2-055 to L-E2-220	Z-Fahrwerk-001
Wheeled chassis for the slurry mixer Type L-E2-055 to L-E2-220 including a height adjustment mechanism	Z-Fahrwerk-002
Oil expansion tank with bracket	Z-Ölbehälter-02
Sacrificial anode with galvanised bracket	Z-Opferanode-01

Price supplement	
Mechanical seal SiC/SiC with oil filling, supplement on mixer	A-Preis-015
Oil filling, supplement on mixer	A-Preis-016



Illustration: Front loader holder for slurry agitator type L-E2

Front loading agitator Hydraulicus

Hydraulicus

Thanks to its slim design, the Hydraulicus is ideal for small openings.

The complete drive technology with orbital motor is directly behind the

agitator blade and forms a unit. The entire head can be tilted by $\pm 90^\circ$ using a socket pin, in order to optimally adapt the agitation jet to the operating conditions.

In addition, the head can easily be converted to have a $\pm 90^\circ$ side adjustment instead of a tilt adjustment. A pressure relief valve is optionally available for an

extra charge. The mount for the front loader will be made to fit upon consultation.

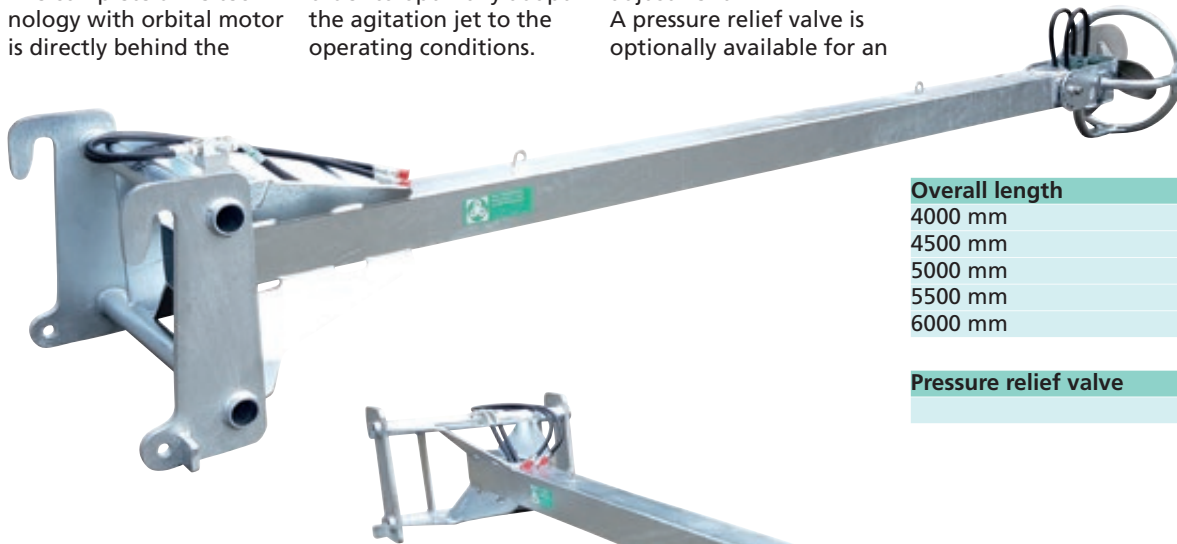

Overall length	Order no.
4000 mm	Hydraulicus-4000
4500 mm	Hydraulicus-4500
5000 mm	Hydraulicus-5000
5500 mm	Hydraulicus-5500
6000 mm	Hydraulicus-6000

Pressure relief valve	Order no.
	Z-Drosselventil-02

Technical data:	
max. continuous pressure:	250 bar
max. oil volume flow:	125 l/min.
Infeed connection:	3/4"
Return connection:	3/4"
Connection for depressurised leakage oil line:	1/4"
maximum speed	380 1/min.
maximum power	35 KW

Agitation jet
 $\pm 90^\circ$ adjustable

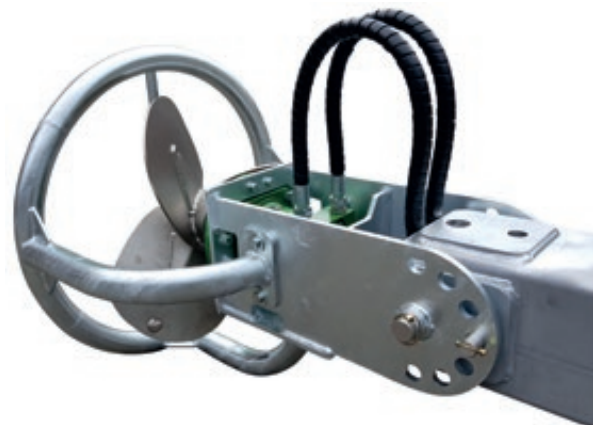
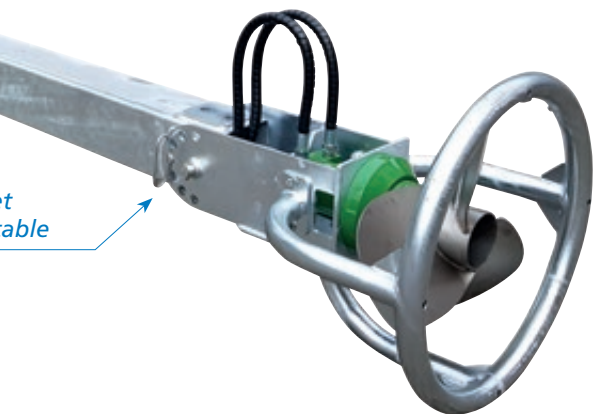
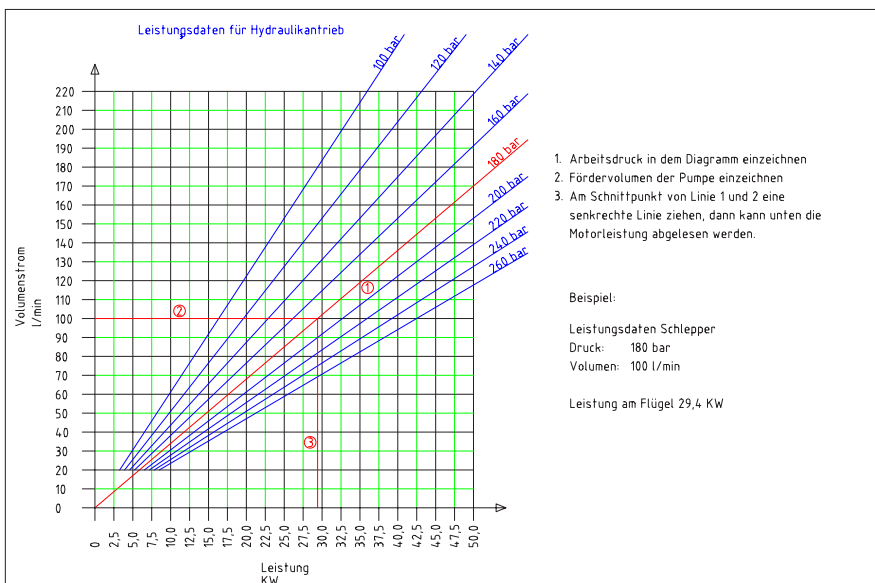

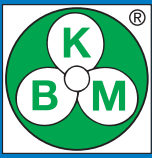

Mixer tower – fixed

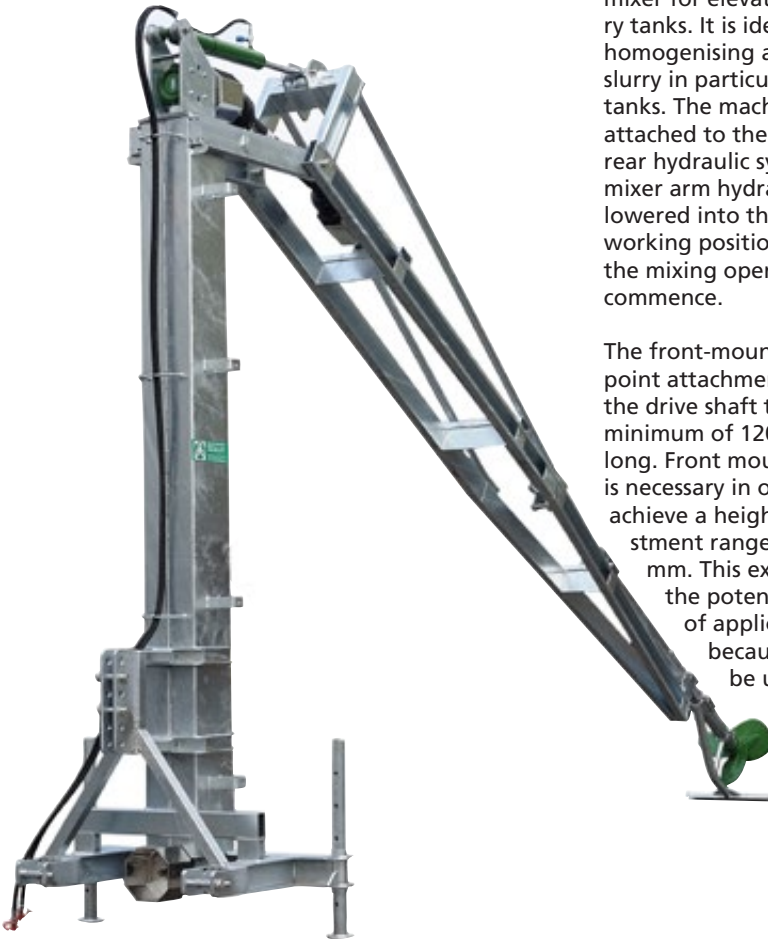

With the mixer tower fitted with the Type E2-102 slurry mixer, BUSCHMANN offers a mobile slurry mixer for elevated slurry tanks. It is ideal for homogenising and mixing slurry in particularly large tanks. The machine is attached to the tractor's rear hydraulic system, the mixer arm hydraulically lowered into the desired working position, and the mixing operation can commence.

The front-mounted three point attachment requires the drive shaft to be a minimum of 1200 mm long. Front mounting is necessary in order to achieve a height adjustment range of 600 mm. This expands the potential range of applications because it can be used to

easily mix slurry tanks of different heights.

The load is taken off the universal joints on the drive shaft. Drive is achieved via 2 angled drives. Using this system, mixer towers of up to 6000 mm in height can be constructed. This design is suitable for applications that require a tilt angle of up to 60°.

Very important:

When using a slurry mixer tower only mixers with pusher propellers may be used!

Standard equipment:

- Mixer tower constructed to the required height, front-mounted three point attachment.
- Mixer tower constructed to the required height, front-mounted three point attachment.

- Hydraulic tilt angle adjustment of the outrigger arm with double-acting hydraulic cylinder, stroke length 600 mm. Cylinder size Ø 80 x Ø 35 x 600
- Two hydraulic hoses with quick connectors. Length corresponds with the installation height
- Outrigger arm for mixer lengths of up to 6000 mm. Maximum working angle 60°. Adjustment range 0° to 60° (90°-30°). The maximum angular load on the universal joints = 32° at the maximum tilt angle of 60°.
- Galvanised construction.
- The basic construction is designed to accept slurry mixers of the E2-102-6000 range. Power transmission 77 kW (105 hp) at 540 rpm, 114 kW (155 hp) at 1000 rpm.

For this design it is imperative that a double-sided wide-angle drive shaft is used. This can be supplied as an accessory item.

Slurry mixer tower – fixed

Galvanised, includes hydraulic tilt angle adjustment and 2 support legs, adjustable. For operation, a double-sided wide-angle drive shaft must be fitted between the tower and the mixer. The listed item numbers do not include the associated slurry mixer.

Installation height	Tank height		Tower without drive shaft	Installation height	Tank height		Tower without drive shaft
	From	To			From	To	
1.000 mm	1.000 mm	1.500 mm	TR-St-1000-oG	3.500 mm	3.500 mm	4.000 mm	TR-St-3500-oG
1.500 mm	1.500 mm	2.000 mm	TR-St-1500-oG	4.000 mm	4.000 mm	4.500 mm	TR-St-4000-oG
2.000 mm	2.000 mm	2.500 mm	TR-St-2000-oG	4.500 mm	4.500 mm	5.000 mm	TR-St-4500-oG
2.500 mm	2.500 mm	3.000 mm	TR-St-2500-oG	5.000 mm	5.000 mm	5.500 mm	TR-St-5000-oG
3.000 mm	3.000 mm	3.500 mm	TR-St-3000-oG	5.500 mm	5.500 mm	6.000 mm	TR-St-5500-oG

Price supplement	Order no.
Extended tower outrigger arm	AP-005
	AP-006
	AP-007
Installation cost:	TR-Mo-001

Accessories	Order no.
Drive shaft, double-sided wide-angle – from tower to mixer	G-06
Drive shaft, double-sided wide-angle – from tower to mixer – heavy duty design	G-09
Drive shaft, single-sided wide-angle – from tractor to tower	G-07
Drive shaft, single-sided wide-angle – from tractor to tower – heavy duty design	G-10

Special accessories can be supplied. See page 61 of the catalogue.

Mixer tower – pivoting series I

Mixer tower, pivots up to 360° depending upon the installation height

Standard equipment:

Same as for the fixed mixer tower (galvanised).

- The tower superstructure stands on a slewing ring and can be **pivoted through 360°**. It is a requirement that the installation height is greater than the height of the tractor!

- The tower is pivoted by hand using the grips provided. It is locked in place using pins.

- The overall construction has four supporting legs.

- The drive shaft with universal joints is concealed within the bracing tube.

- The overall construction is designed to accept slurry mixers of the E2-102-6000 range. Power transmission 77 kW (105 hp) at 540 rpm, 114 kW (155 hp) at 1000 rpm.

- Corresponding counterweights with painted handles.



Slurry mixer tower – pivoting

Galvanised, includes hydraulic tilt angle adjustment and 4 support legs, adjustable. For operation, a double-sided wide-angle drive shaft must be fitted between the tower and the mixer. The listed item numbers do not include the associated slurry mixer.

Installation height	Tank height From	To	Tower without drive shaft	Installation height	Tank height From	To	Tower without drive shaft
1.000 mm	1.000 mm	1.500 mm	TR-Dr-1000-oG	3.500 mm	3.500 mm	4.000 mm	TR-Dr-3500-oG
1.500 mm	1.500 mm	2.000 mm	TR-Dr-1500-oG	4.000 mm	4.000 mm	4.500 mm	TR-Dr-4000-oG
2.000 mm	2.000 mm	2.500 mm	TR-Dr-2000-oG	4.500 mm	4.500 mm	5.000 mm	TR-Dr-4500-oG
2.500 mm	2.500 mm	3.000 mm	TR-Dr-2500-oG	5.000 mm	5.000 mm	5.500 mm	TR-Dr-5000-oG
3.000 mm	3.000 mm	3.500 mm	TR-Dr-3000-oG	5.500 mm	5.500 mm	6.000 mm	TR-Dr-5500-oG
Price supplement							Order no.
Extended tower outrigger arm			Up to a mixer length of 7.000 mm				AP-005
			Up to a mixer length of 8.000 mm				AP-006
			Up to a mixer length of 9.000 mm				AP-007
Installation cost:			Final on-site installation, assuming lifting gear is available on-site with operating personnel				TR-Mo-001
Accessories							Order no.
Drive shaft, double-sided wide-angle – from tower to mixer							G-06
Drive shaft, double-sided wide-angle – from tower to mixer – heavy duty design							G-09
Drive shaft, single-sided wide-angle – from tractor to tower							G-07
Drive shaft, single-sided wide-angle – from tractor to tower – heavy duty design							G-10

Special accessories for Slurry mixer tower

Order no.:

Pivoting adjustment	360°, depending upon installation height, via a gear rim with oil motor, locking using pins	Z-TR-001
Pivoting adjustment	Via a double-acting hydraulic cylinder, stroke length 350, locking using pins	Z-TR-002
Hydraulic height adjustment	Square profile sections form the column, with telescopic extension via a double-acting hydraulic cylinder, including the block valve.	
	For use above an installation height of 1500: Adjustment range 0 – 550 mm	AP-008
	For use above an installation height of 2000: Adjustment range 0 – 700 mm	AP-009
	For use above an installation height of 2500: Adjustment range 0 – 1000 mm	AP-010
	For use above an installation height of 3000: Adjustment range 0 – 1300 mm	AP-011
	For use above an installation height of 3500: Adjustment range 0 – 1600 mm	AP-012
	For use above an installation height of 4000: Adjustment range 0 – 2000 mm	AP-013
	Central hydraulic valve, electric, mounted on the mixer tower, including control console, Radio remote control, connector cable and 2 hydraulic hoses with quick couplers	AP-014
Working platform	With safety rail, mounted on the mixer tower	AP-015
Access ladder	To the working platform, mounted on the mixer tower, fixed	
	Up to an installation height 1500	Z-TR-003
	Up to an installation height 2000	Z-TR-004
	Up to an installation height 3000	Z-TR-005
	Up to an installation height 4000	Z-TR-006
Access ladder	To the height adjustable mixer tower, with telescopic extension	
	Up to an installation height 1500	Z-TR-007
	Up to an installation height 2000	Z-TR-008
	Up to an installation height 3000	Z-TR-009
	Up to an installation height 4000	Z-TR-010
Support device		Z-TR-011
Throttle valve for the hydraulic cylinder		Z-Drosselventil-01

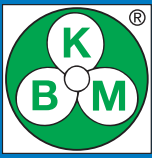

Mixer tower – pivoting series II

- Pivoting adjustment is carried out via a hydraulic cylinder which moves the ball bearing supported slewing ring to the required position.
- The overall structure has four manually height-adjustable and two additional hydraulic side supports for safe and easy alignment.
- Power transmission is carried out via two powerful angular gears which are connected to an interior shaft. (Designed for power take-off shaft speeds up to 1000 rpm.)
- A central hydraulic valve with radio remote control makes handling even more easy.
- Hop-dip galvanised design, as far as possible
- The basic price includes a tower outrigger arm, suitable for a mixer length of 6000 mm. An extended tower outrigger arm up to 10000 mm can be supplied for elevated tanks. The mixer is not included in the basic price.
- Depending on the tower height, hydraulic height adjustment (up to 1.0 meter) is available for a price supplement.

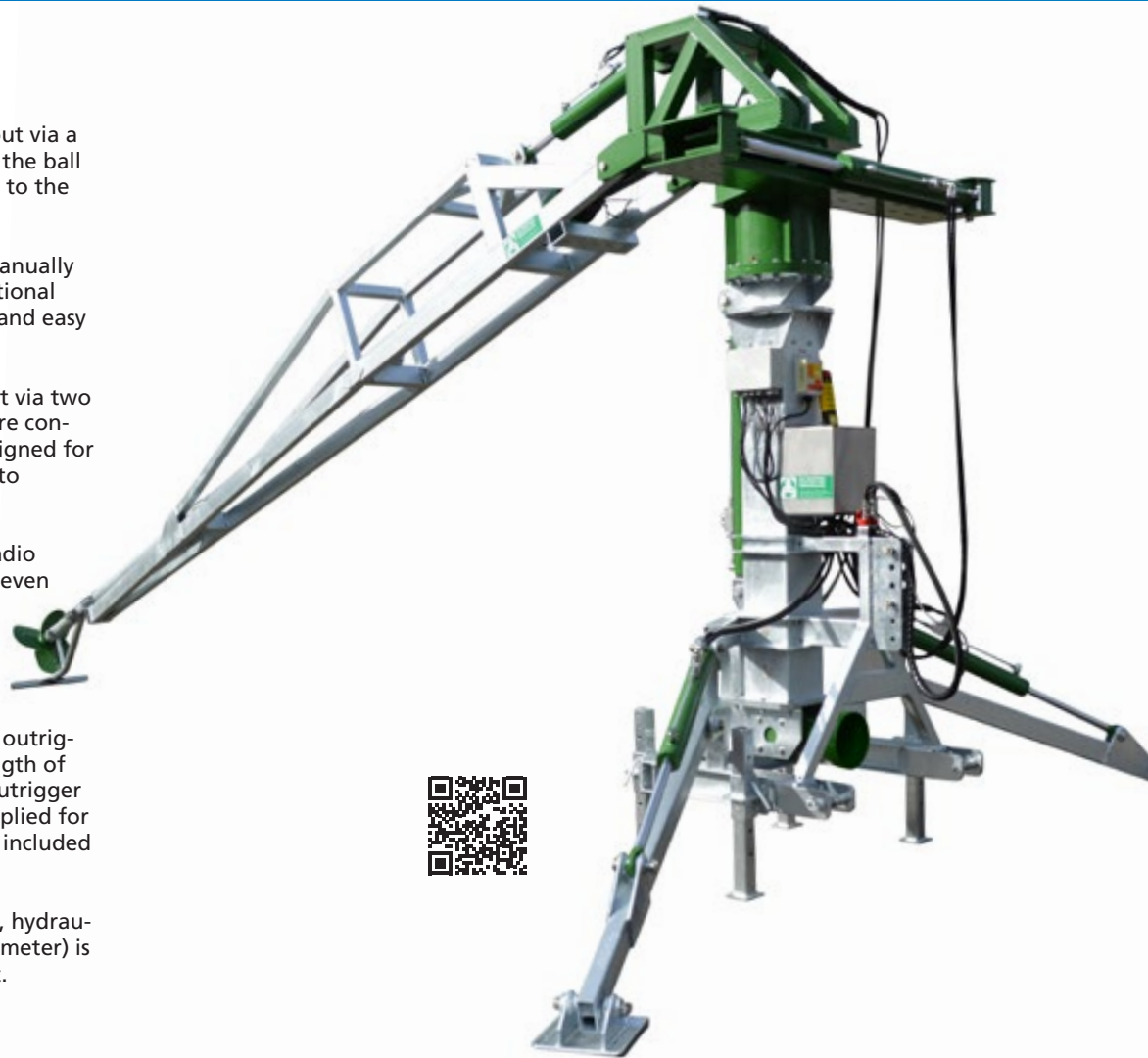

Slurry mixer tower, pivoting series II

Galvanised, including hydraulic tilt and rotation adjustment, as well as two hydraulic side supports, four standard adjustable feet and a central hydraulic valve with radio remote control. A double-sided wide-angle drive shaft from the tower to the mixer is required for use. The listed item numbers do not include the matching mixer.

Installation height	Tank height		Tower without drive shaft	Installation height	Tank height		Tower without drive shaft
	From	To			From	To	
1.000 mm	1.000 mm	1.500 mm	TR-Dr-1000-oG-2Hy	3.500 mm	3.500 mm	4.000 mm	TR-Dr-3500-oG-2Hy
1.500 mm	1.500 mm	2.000 mm	TR-Dr-1500-oG-2Hy	4.000 mm	4.000 mm	4.500 mm	TR-Dr-4000-oG-2Hy
2.000 mm	2.000 mm	2.500 mm	TR-Dr-2000-oG-2Hy	4.500 mm	4.500 mm	5.000 mm	TR-Dr-4500-oG-2Hy
2.500 mm	2.500 mm	3.000 mm	TR-Dr-2500-oG-2Hy	5.000 mm	5.000 mm	5.500 mm	TR-Dr-5000-oG-2Hy
3.000 mm	3.000 mm	3.500 mm	TR-Dr-3000-oG-2Hy	5.500 mm	5.500 mm	6.000 mm	TR-Dr-5500-oG-2Hy

Price supplement	Order no.	
Hydraulic height adjustment via a double-acting cylinder	AP-017	
Extended tower outrigger arm	Up to a mixer length of 7.000 mm	AP-005
	Up to a mixer length of 8.000 mm	AP-006
	Up to a mixer length of 9.000 mm	AP-007
	Up to a mixer length of 10.000 mm	AP-016
Installation cost:	Final on-site installation, assuming lifting gear is available on-site with operating personnel	TR-Mo-001

Zubehör	Order no.
Drive shaft, double-sided wide-angle – from tower to mixer	G-06
Drive shaft, double-sided wide-angle – from tower to mixer – heavy duty design	G-09
Drive shaft, single-sided wide-angle – from tractor to tower	G-07
Drive shaft, single-sided wide-angle – from tractor to tower – heavy duty design	G-10
Support device	Z-TR-011

Mixer tower – pivoting series II



Illustrations: Mixer tower, self-supporting, pivots through 225°

Installation height 3000 mm

With central hydraulic valve and radio remote control

With hydraulically extendible side feet

With hydraulic pivoting adjustment

Plus hydraulic height adjustment 1000 mm

Mixer type E2-102-7.000

with pusher propeller Ø 560

With heavy duty propeller skid

Plus wide-angle drive shaft G-06

Plus wide-angle drive shaft G-07





CircumMaxx

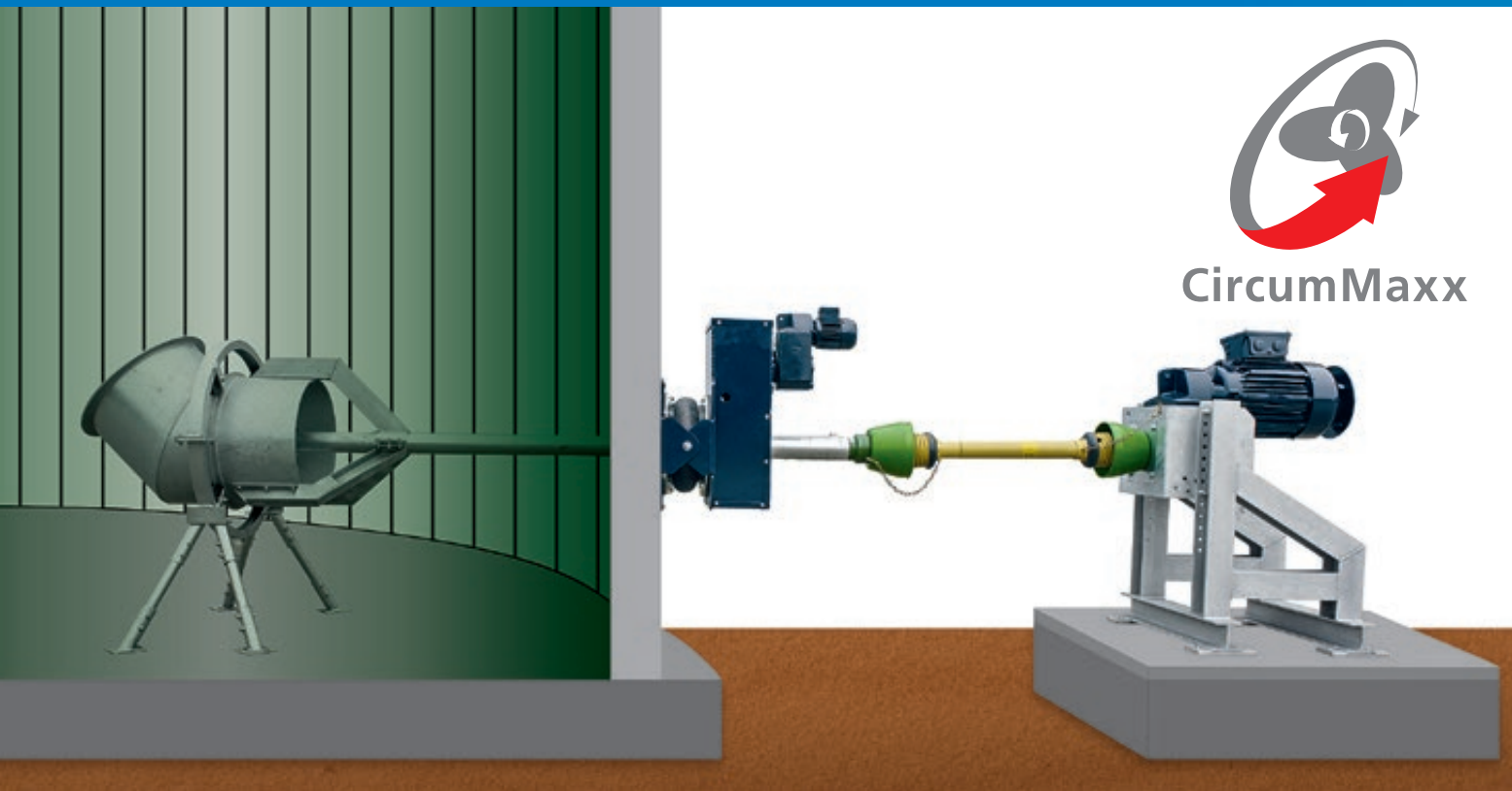

CircumMaxx

Circumferential agitator against sinking and floating layers

CircumMaxx is an intelligent and substrate flexible agitator. The unique combination of agitator direction and power enables a three-dimensional mix. Consequently, both sinking and floating layers can be treated preventively and dissolved safely with minimal expenditure of energy.

In order to respond to changing conditions, modern fermentation plants' agitators need to adjust flexibly. CircumMaxx is automatically and flexibly adjustable to changing situations. The proven pivoting agitator nozzle-technique, which is combined with an automatic 360° position encoder, detects all directions in the fermenter.

In conjunction with intelligent controlling technology, it is possible to implement a variety of mixing-scenarios, which can be integrated specifically into the procedure. This ensures an energy-optimized mixing of the complete content. The microorganisms will be distributed ideally and reduce the residual gas potential.

CircumMaxx can be installed in any type of container. The well thought-out construction allows easy installation also on existing containers.



Technical data

Mixing in three-dimensional space

Length	Inside: ca. 2.000 mm Outside: ca. 3.000 mm
Material	galvanized steel stainless steel (optional)
Drive	electric drive: 15 to 30 kW tractor drive: up to 150 kW
Agitator nozzle	45° at Ø 600 mm 360° free swiveling traversable with stepper motor
Control	optional pushbutton r/l in steps of 5° or by integration in MSR
Propeller	Ø ca. 560 mm
Sealing	ca. 30 m submersible
Embedding	ground foundation No power transmission onto container wall

Subject to technical changes!

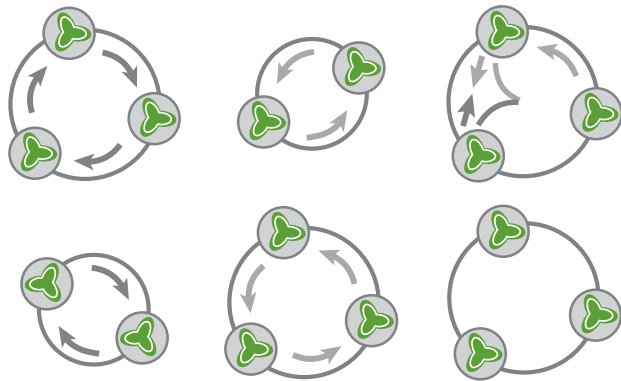

Your advantages at a glance:

☑ Powerful nozzle technology

- Position of the nozzles are automatically variable and adjustable
- Driven by an electric motor or 150 kW tractor operation
- Termination system for all types of liquid manure containers can be achieved

☑ Dynamic stirring in 3-D

- Any layer in the fermenter can be steered specifically
- Flexible use for any container geometry
- Variable even in substrate flexibility

☑ CircumMaxx – simple and robust

- Broad application possibilities
- Safe operation, redundant drive
- Simple installation and maintenance, visible technology
- intelligent substrate-flexible mixing

Variable stirring positions

By varying

- ☑ number of agitators
- ☑ driving power of the agitators
- ☑ nozzle position
- ☑ synchronization of the agitators
- ☑ automatic program selection

it is possible to control any position in the fermenter. Furthermore, combinations with additional agitators are also possible.

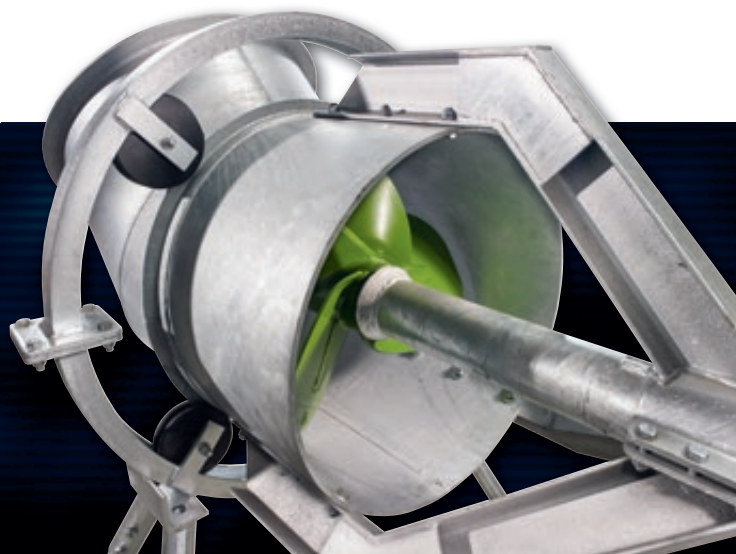

Should you need further information about our innovative products? Please do not hesitate to contact us. We will be pleased to advise you!

RÖRING
ENERGIE-ANLAGEN

Energie-Anlagen Röring GmbH
Rudolf-Diesel-Straße 3b - 48691 Vreden

Phone: + 49 2564 394939-0
Fax: + 49 2564 394939-49

info@energieanlagen-roering.de
www.energieanlagen-roering.de



PlurryMaxx – The wet-disintegrator

Mechanical disintegration with cavitation effects

PlurryMaxx is a device for mechanical comminution and for the enlargement of the substrate surface for an improved fermentation. This is one of the most efficient disintegration techniques. The fermentation substrate is pumped through the cutting cylinder and finely chopped by a rapidly rotating blade hammer with a flow ring. At high

cutting speeds, the substrate to be fermented is ideally prepared for the microorganisms. In addition, alternative and fibrous substrates can be used. This added available degradable organic material provides a bigger yield of biogas.

Varieties of installation suitable for every anaerobic digestion plant

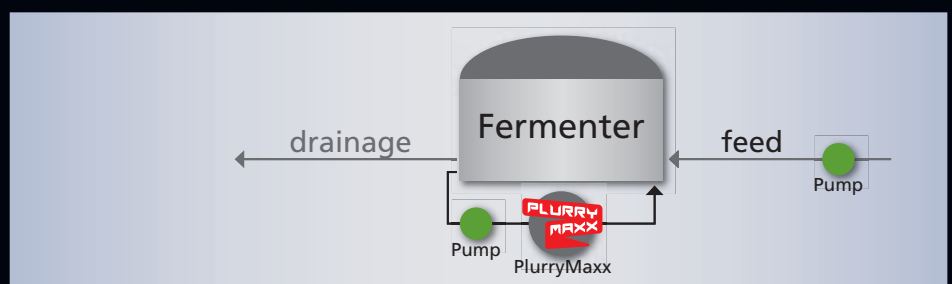
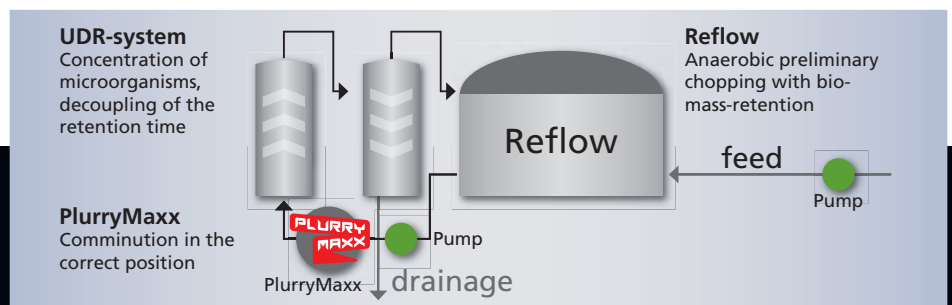

Technical data

High performance in a small space

L / W / H	ca. 980 / ca. 1.400 / ca. 2.150 (ca. 2.500) mm
Material	coated steel
Drive	Electric motor 37 kW, 45 kW on request
Blade hammer	1 blade hammer made of wear-resistant steel
Control	Manually on time or via integration in MSR
Cylinder	500 mm, cutting body with return
Sealing	Special bearing up to 4.000 rpm
Anchorage	Mounted on base plate with dampers, base plate is anchored to bottom
Performance	approx. 10 – 20 m ³ /h, the throughput depends on the substrate

Registered utility model Nr. 20 2012 104 378.5

Patent pending. (Subject to technical changes.)

PlurryMaxx ensures safe and upgraded operation of the plant with higher gas yield. By using PlurryMaxx, the residence time can be reduced while increasing the degree of degradation and thus the biogas production.

With the compact method of construction, PlurryMaxx can be merged ideally into existing plants or installed into a compact-container.

Your advantages at a glance:

☑ Reduced susceptibility

- No counter cutting
- Less floating layer inclination
- Increased digestion
- Full flow and partial flow treatable
- Avoids blockages in pipes and pumps
- The PlurryMaxx cannot disturb the system function
- When the device is switched off, the substrate can flow through unhindered
- Very variable use
- Extremely robust against impurities

☑ Additional yield through cavitation

- Release of organic matter
- Higher biogas potential
- Availability for microorganisms
- Lower internal shear forces reduce demand of stirring energy

☑ Increasing substrate efficiency

- Use of agricultural residues
- Fibrous input materials (manure, whole plant silage, straw)
- bigger yield, low costs



Should you need further information about our innovative products? Please do not hesitate to contact us. We will be pleased to advise you!

RÖRING
ENERGIE-ANLAGEN

Energie-Anlagen Röring GmbH
Rudolf-Diesel-Straße 3b - 48691 Vreden

Phone: + 49 2564 394939-0
Fax: + 49 2564 394939-49

info@energieanlagen-roering.de
www.energieanlagen-roering.de

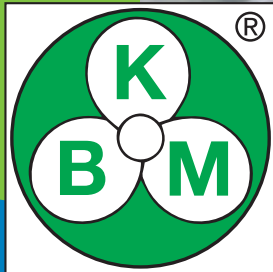

Karl Buschmann Maschinenbau GmbH

Industriestraße 18 • 46499 Hamminkeln • GERMANY

Phone +49 (0) 28 52 96 69 0 • Fax +49 (0) 28 52 38 62

E-mail: info@guelleruehrwerke.de

www.guelleruehrwerke.de



Your specialist dealer: